

# BK PRECISION®

## 9830B Series USER MANUAL

Model: 9832B, 9833B

High Power Programmable AC Power Sources



# 1 Safety Summary

The following safety precautions apply to both operating and maintenance personnel and must be followed during all phases of operation, service, and repair of this instrument.

## **WARNING**

Before applying power to this instrument:

- Read and understand the safety and operational information in this manual.
- Apply all the listed safety precautions.
- Verify that the voltage selector at the line power cord input is set to the correct line voltage. Operating the instrument at an incorrect line voltage will void the warranty.
- Make all connections to the instrument before applying power.
- Do not operate the instrument in ways not specified by this manual or by B&K Precision.

Failure to comply with these precautions or with warnings elsewhere in this manual violates the safety standards of design, manufacture, and intended use of the instrument. B&K Precision assumes no liability for a customer's failure to comply with these requirements.

### ***Category rating***

The IEC 61010 standard defines safety category ratings that specify the amount of electrical energy available and the voltage impulses that may occur on electrical conductors associated with these category ratings. The category rating is a Roman numeral of I, II, III, or IV. This rating is also accompanied by a maximum voltage of the circuit to be tested, which defines the voltage impulses expected and required insulation clearances. These categories are:

Category I (CAT I): Measurement instruments whose measurement inputs are not intended to be connected to the mains supply. The voltages in the environment are typically derived from a limited-energy transformer or a battery.

Category II (CAT II): Measurement instruments whose measurement inputs are meant to be connected to the mains supply at a standard wall outlet or similar sources. Example measurement environments are portable tools and household appliances.

Category III (CAT III): Measurement instruments whose measurement inputs are meant to be connected to the mains installation of a building. Examples are measurements inside a building's circuit breaker panel or the wiring of permanently-installed motors.

Category IV (CAT IV): Measurement instruments whose measurement inputs are meant to be connected to the primary power entering a building or other outdoor wiring.

## **WARNING**

Do not use this instrument in an electrical environment with a higher category rating than what is specified in this manual for this instrument.

## **WARNING**

You must ensure that each accessory you use with this instrument has a category rating equal to or higher than the instrument's category rating to maintain the instrument's category rating. Failure to do so will lower the category rating of the measuring system.

### ***Electrical Power***

This instrument is intended to be powered from a CATEGORY II mains power environment. The mains power should be between 190 V to 250 V RMS. Use only the power cord supplied with the instrument and ensure it is appropriate for your country of use.

### ***Ground the Instrument***

## **WARNING**

To minimize shock hazard, the instrument chassis and cabinet must be connected to an electrical safety ground. This instrument is grounded through the ground conductor of the supplied, three-conductor AC line power cable. The power cable must be plugged into an approved three-conductor electrical outlet. The power jack and mating plug of the power cable meet IEC safety standards.

## **WARNING**

Do not alter or defeat the ground connection. Without the safety ground connection, all accessible conductive parts (including control knobs) may provide an electric shock. Failure to use a properly-grounded approved outlet and the recommended three-conductor AC line power cable may result in injury or death.

## **WARNING**

Unless otherwise stated, a ground connection on the instrument's rear panel is for a reference of potential only and is not to be used as a safety ground.

***Do not operate in an explosive or flammable atmosphere***

## **WARNING**

Do not operate the instrument in the presence of flammable gases or vapors, fumes, or finely-divided particulates.

## **WARNING**

The instrument is designed to be used in office-type indoor environments. Do not operate the instrument

- In the presence of noxious, corrosive, or flammable fumes, gases, vapors, chemicals, or finely-divided particulates.
- In relative humidity conditions outside the instrument's specifications.
- In environments where there is a danger of any liquid being spilled on the instrument or where any liquid can condense on the instrument.
- In air temperatures exceeding the specified operating temperatures.
- In atmospheric pressures outside the specified altitude limits or where the surrounding gas is not air.
- In environments with restricted cooling air flow, even if the air temperatures are within specifications.
- In direct sunlight.

## **CAUTION**

This instrument is intended to be used in an indoor pollution degree 2 environment. The operating temperature range is 0 °C to 40 °C and 20% to 80% relative humidity, with no condensation allowed.

Measurements made by this instrument may be outside specifications if the instrument is used in non-office-type environments. Such environments may include rapid temperature or humidity changes, sunlight, vibration and/or mechanical shocks, acoustic noise, electrical noise, strong electric fields, or strong magnetic fields.

***Do not operate instrument if damaged***

## **WARNING**

If the instrument is damaged, appears to be damaged, or if any liquid, chemical, or other material gets on or inside the instrument, remove the instrument's power cord, remove the instrument from service, label it as not to be operated, and return the instrument to B&K Precision for repair. Notify B&K Precision of the nature of any contamination of the instrument.

***Clean the instrument only as instructed***

## **WARNING**

Do not clean the instrument, its switches, or its terminals with contact cleaners, abrasives, lubricants, solvents, acids/bases, or other such chemicals. Clean the instrument only with a clean dry lint-free cloth or as instructed in this manual.

***Not for critical applications***

**⚠ WARNING**

This instrument is not authorized for use in contact with the human body or for use as a component in a life-support device or system.

***Do not touch live circuits***

**⚠ WARNING**

Instrument covers must not be removed by operating personnel. Component replacement and internal adjustments must be made by qualified service-trained maintenance personnel who are aware of the hazards involved when the instrument's covers and shields are removed. Under certain conditions, even with the power cord removed, dangerous voltages may exist when the covers are removed. To avoid injuries, always disconnect the power cord from the instrument, disconnect all other connections (for example, test leads, computer interface cables, etc.), discharge all circuits, and verify there are no hazardous voltages present on any conductors by measurements with a properly-operating voltage-sensing device before touching any internal parts. Verify the voltage-sensing device is working properly before and after making the measurements by testing with known-operating voltage sources and test for both DC and AC voltages. Do not attempt any service or adjustment unless another person capable of rendering first aid and resuscitation is present.

Do not insert any object into an instrument's ventilation openings or other openings.

**⚠ WARNING**

Hazardous voltages may be present in unexpected locations in circuitry being tested when a fault condition in the circuit exists.

***Fuse replacement***

**⚠ WARNING**

Fuse replacement must be done by qualified service-trained maintenance personnel who are aware of the instrument's fuse requirements and safe replacement procedures. Disconnect the instrument from the power line before replacing fuses. Replace fuses only with new fuses of the fuse types, voltage ratings, and current ratings specified in this manual or on the back of the

instrument. Failure to do so may damage the instrument, lead to a safety hazard, or cause a fire. Failure to use the specified fuses will void the warranty.

### ***Servicing***

## **⚠ CAUTION**

Do not substitute parts that are not approved by B&K Precision or modify this instrument. Return the instrument to B&K Precision for service and repair to ensure that safety and performance features are maintained.

### ***For continued safe use of the instrument***

Do not place heavy objects on the instrument.

- Do not obstruct cooling air flow to the instrument.
- Do not place a hot soldering iron on the instrument.
- Do not pull the instrument with the power cord, connected probe, or connected test lead.
- Do not move the instrument when a probe is connected to a circuit being tested.

## Compliance Statements

Disposal of Old Electrical & Electronic Equipment (Applicable in the European Union and other European countries with separate collection systems)

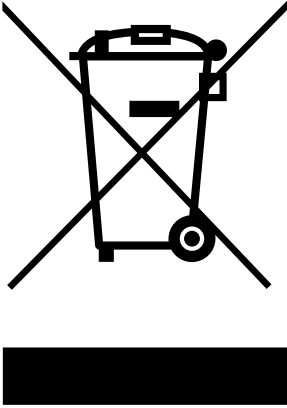

This product is subject to Directive 2002/96/EC of the European Parliament and the Council of the European Union on waste electrical and electronic equipment (WEEE), and in jurisdictions adopting that Directive, is marked as being put on the market after August 13, 2005, and should not be disposed of as unsorted municipal waste. Please utilize your local WEEE collection facilities in the disposition of this product and otherwise observe all applicable requirements.













## CE Declaration of Conformity

This instrument meets the requirements of EMC Directive 2014/30/EU Electromagnetic Compatibility Directive and the following standards.





### EMC Directive

- EN 61326-1:2013 Class A
- EN 61326-2-1:2013
- EN 61000-3-12:2011
- EN 61000-3-11:2000
- EN 61326-1:2013 (industrial locations)
- EN 610000-4-2:2009
- EN 610000-4-3:2006+A1:2008+2010
- EN 610000-4-4:2012
- EN 610000-4-5:2014
- EN 610000-4-6:2010
- EN 610000-4-8:2010
- EN 610000-4-34:2007+A1:2009

## Safety Symbols

	Refer to the user manual for warning information to avoid hazard or personal injury and prevent damage to instrument.
	Electric Shock hazard
	Hot surface
	On (Power). Press the “I” at the top of the power switch to turn the instrument ON.
	Off (Power). Press the “O” at the bottom of the power switch to turn the instrument off.
	Direct current (DC)
	Alternating current (AC)
	Direct and alternating current (DC + AC)
	Chassis (earth ground) symbol
	Ground terminal
	Protective earth ground
	Fuse Symbol
CAT I (1000V)	IEC Measurement Category I. Inputs may be connected to mains (up to 1000 VAC) under Category I overvoltage conditions.
CAT II (300V)	IEC Measurement Category II. Inputs may be connected to mains (up to 300 VAC) under Category II overvoltage conditions.



	<p>CAUTION indicates a hazardous situation which, if not avoided, will result in minor or moderate injury</p>
	<p>WARNING indicates a hazardous situation which, if not avoided, could result in death or serious injury</p>
	<p>DANGER indicates a hazardous situation which, if not avoided, will result in death or serious injury.</p>
	<p>NOTICE is used to address practices not related to physical injury.</p>
	<p>Safety instructions (or equivalent) signs indicate specific safety-related instructions or procedures</p>

## 2 Notations

**TEXT** – Denotes a softkey.

**TEXT** – Denotes a front panel key.

Table of Contents

- 1 Safety Summary ..... i**
  - Compliance Statements.....vi
  - Safety Symbol .....vii
- 2 Notations .....ix**
- 3 General Information..... 1**
  - 3.1 Package Contents ..... 1
  - 3.2 Product Dimensions..... 2
  - 3.3 Installation ..... 3
  - 3.4 Front Panel..... 4
  - 3.5 Rear Panel..... 6
- 4 Display Overview ..... 7**
  - 4.1 Display Description ..... 7
- 5 Getting Started..... 10**
  - 5.1 Input Power Requirements ..... 10
    - 5.1.1 North American Split Phase Power ..... 10
    - 5.1.2 Fuse ..... 12
  - 5.2 Preliminary Check..... 12
    - 5.2.1 Power-on Procedure ..... 12
    - 5.2.2 Warm-up Time ..... 13
    - 5.2.3 Power-off Procedure ..... 13
  - 5.3 Sense Lines..... 13
- 6 Menu Tree ..... 15**
- 7 Front Panel Operation ..... 16**
  - 7.1 Configure Voltage and Frequency Output..... 16
    - 7.1.1 Setting voltage..... 16
    - 7.1.2 Setting frequency ..... 16
    - 7.1.3 Setting Voltage ..... 17
  - 7.2 Program Settings ..... 18
    - 7.2.1 Step Mode ..... 18
    - 7.2.2 List Mode..... 20
    - 7.2.3 Pulse Mode..... 25
- 8 Configure Menu ..... 27**

8.1	Config 1 .....	27
8.2	Config 2 .....	28
8.3	Limits.....	30
<b>9</b>	<b>System Settings.....</b>	<b>32</b>
9.1	System Setup .....	32
9.2	Communication Setup .....	33
9.3	System Error .....	34
9.4	System Next.....	35
9.5	Recall Default.....	35
<b>10</b>	<b>Save.....</b>	<b>37</b>
10.1	Save Config .....	37
10.2	Save Screen.....	38
10.3	Recall Configuration .....	38
<b>11</b>	<b>3-Phase Operation .....</b>	<b>40</b>
11.1	Setup and Configuration.....	40
11.2	3-Phase Adapter Digital I/O Pin Definitions .....	42
11.3	3-Phase Output Wiring .....	43
11.4	Phase Control Software.....	44
11.4.1	Operation Modes Overview .....	44
11.4.2	Setup and Configuration.....	46
11.4.3	Three-Phase Application Mode .....	46
11.4.4	Multi-Phase Application Mode.....	49
<b>12</b>	<b>Remote Interface Operation.....</b>	<b>53</b>
12.1	Interface Connection .....	53
12.1.1	RS232 .....	53
12.1.2	USBVCP (virtual COM) .....	53
12.1.3	USBTMC .....	54
12.1.4	GPIB .....	54
12.1.5	LAN (Ethernet).....	54
12.1.6	Web server.....	54
<b>13</b>	<b>Digital I/O .....</b>	<b>58</b>
13.1	External Voltage Control.....	59
13.1.1	AC Couple.....	60
13.1.2	DC Couple .....	60
13.2	Trigger In.....	60

13.3	15 VDC .....	61
13.4	Output Status Detection.....	62
13.4.1	/SYNC .....	62
13.4.2	/Fault_out .....	63
13.4.3	/Transient .....	63
13.5	Remote_Inhibit.....	64
13.6	Tx / Rx .....	64
13.7	Event_SW.....	65
13.8	Analog input (BNC) .....	66
<b>14</b>	<b>Built-in Harmonic Wave.....</b>	<b>68</b>
<b>15</b>	<b>Calibration .....</b>	<b>83</b>
15.1	AC Voltage Calibration.....	83
15.1.1	300V range calibration .....	84
15.1.2	150V range calibration .....	85
15.1.3	DC Voltage Calibration.....	85
15.1.4	AC Current Calibration.....	86
15.1.5	Restore to Factory Default (RECALL DATA) .....	87
15.1.6	External Voltage Calibration .....	88
<b>16</b>	<b>Specifications.....</b>	<b>91</b>
<b>17</b>	<b>LIMITED THREE-YEAR WARRANTY .....</b>	<b>94</b>

## 3 General Information

The B&K Precision 9830B series are low distortion single phase AC power sources delivering a maximum of 3000 VA, 300 Vrms, 30 Arms /97.5 Apk. The Output frequency is adjustable from 45 Hz to 1200 Hz. All models are capable of outputting AC, DC or AC+DC. Predefined waveforms include sine, square, clipped sine and THD waveforms. Standard remote interface include USBVCP and USBTMC-compliant. RS232, LAN, and GPIB interfaces are available to provide flexibility for remote operation.

### Features

- Output AC, DC or AC+DC
- 3-Phase capability using 3 AC sources and the 3-Phase kit (TL983P-KIT)
- Built-in power factor correction (PFC) circuit at the AC input
- Low harmonic distortion
- Power Line Disturbance simulation
- Step, pulse and list modes
- Adjustable phase angle control
- Built-in and user definable waveforms
- Digital I/O port for external trigger, remote inhibit, command completion, failure status,
- Analog input for external control

Comprehensive protection modes including OVP, OCP, OTP, fan failure, key lock

### 3.1 Package Contents

Please inspect the instrument mechanically and electrically upon receiving it. Unpack all items from the shipping carton, and check for any obvious signs of physical damage that may have occurred during transportation. Report any damage to the shipping agent immediately. Save the original packing carton for possible future reshipment. Every instrument is shipped with the following contents:

1 x 9832B or 9833B AC Power Source

- 1 x AC input power cord
- 1 x Certificate of calibration
- 1 x Test report

Verify that all items above are included in the shipping container. If anything is missing, please contact **B&K Precision**.

Note: Check that you have the most current User manual. This is available for download at [www.bkprecision.com](http://www.bkprecision.com)

### 3.2 Product Dimensions

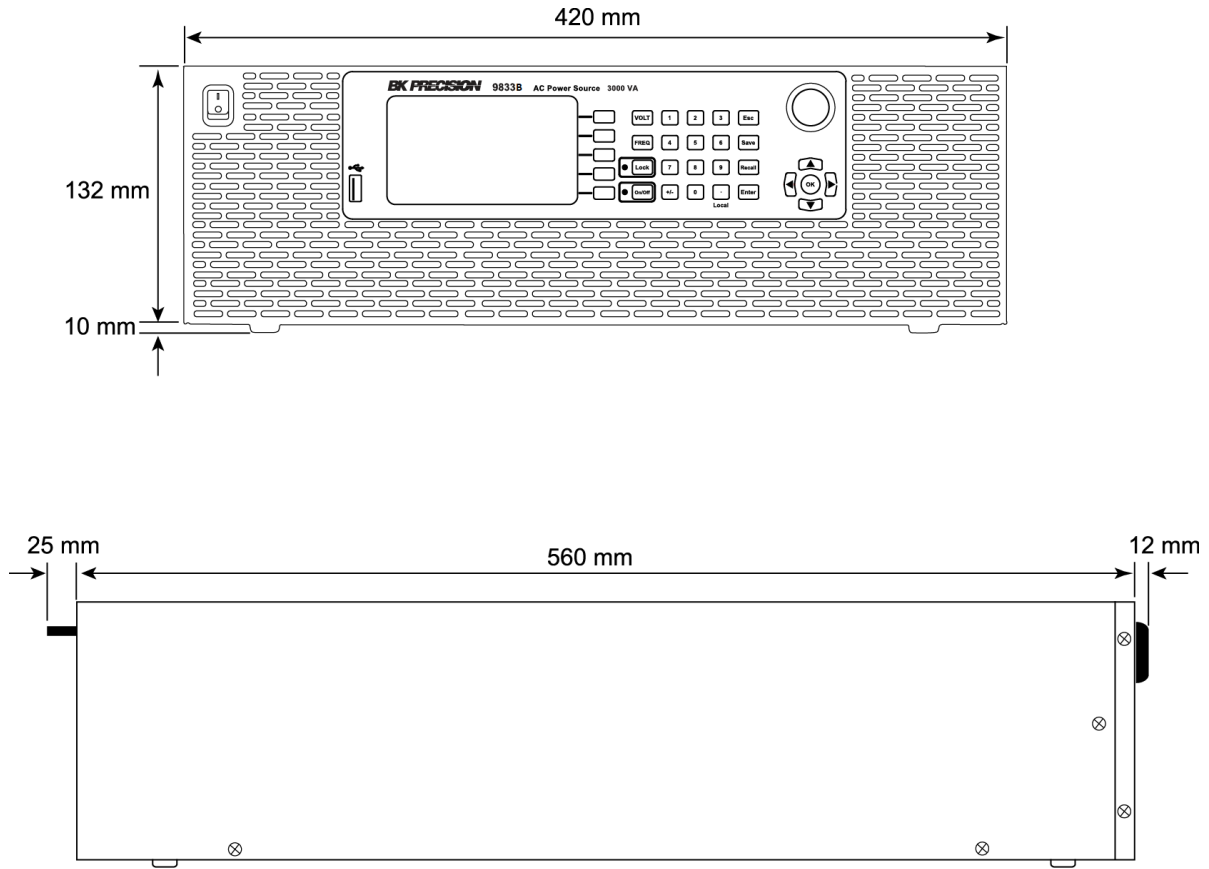

Figure 1 - Dimensions

### 3.3 Installation

The following diagram shows how to install the optional rack mount kit.

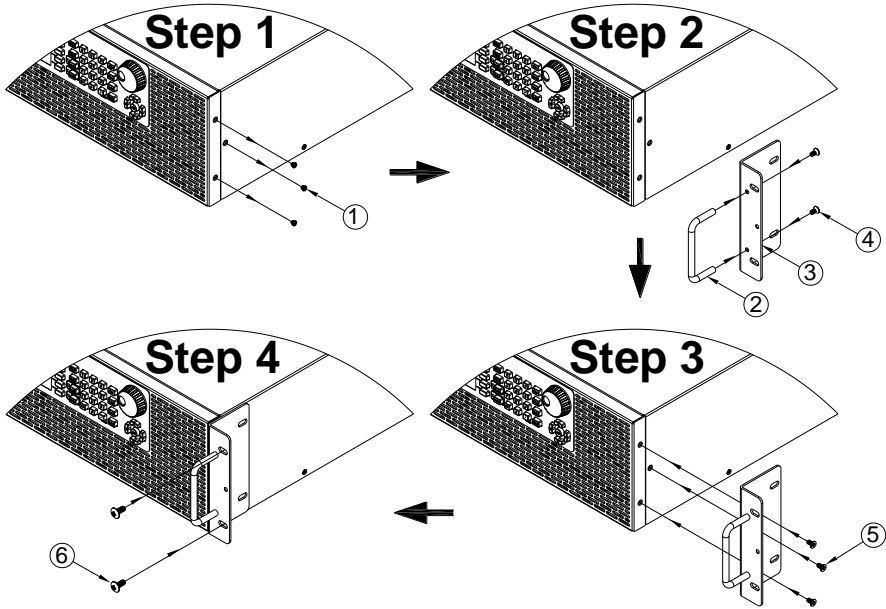

Figure 2 - Rack Mount Kit



### 3.4 Front Panel

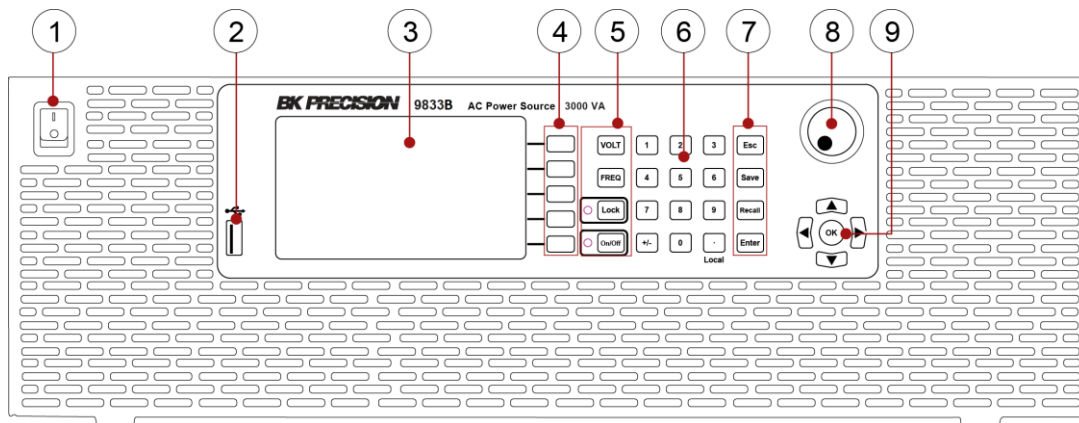

Figure 3 - Front Panel

- 
- ① Power ON/OFF

---

  - ② USB disk port

---

  - ③ VFD

---

  - ④ Softkeys

---

  - ⑤ Function keys & Indicator LEDs

---

  - ⑥ Number keys

---

  - ⑦ Function keys









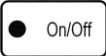

---

  - ⑧ Rotary knob

---

  - ⑨ Direction keys

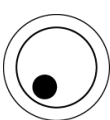
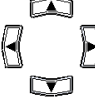
---

Key	Definition
FREQ	Frequency key, press to set the output frequency
VOLT	Voltage key, press to set the output voltage
	Press to lock the keyboard, (Keyboard is locked when LED is illuminated).
	Output On/Off key, press to enable/disable voltage output, (Output is On when LED is illuminated).
	Number key 1 to 9 for direct numeric entry.
	Set the number entered to a positive or negative value.
	Main function: decimal point Secondary function: switch from remote control to local control
	Escape key, press to escape the settings menu or cancel the current settings
	Save key, store configurations and settings into the internal memory or a USB disk
	Recall key, recall data from internal storage or external USB disk
	Enter key, press to confirm the settings change
	Rotary, to adjust value or make up/down selection (press it for ENTER function)
	Up/Down/Left/Right direction keys
	Confirm key, press to confirm the settings

### 3.5 Rear Panel

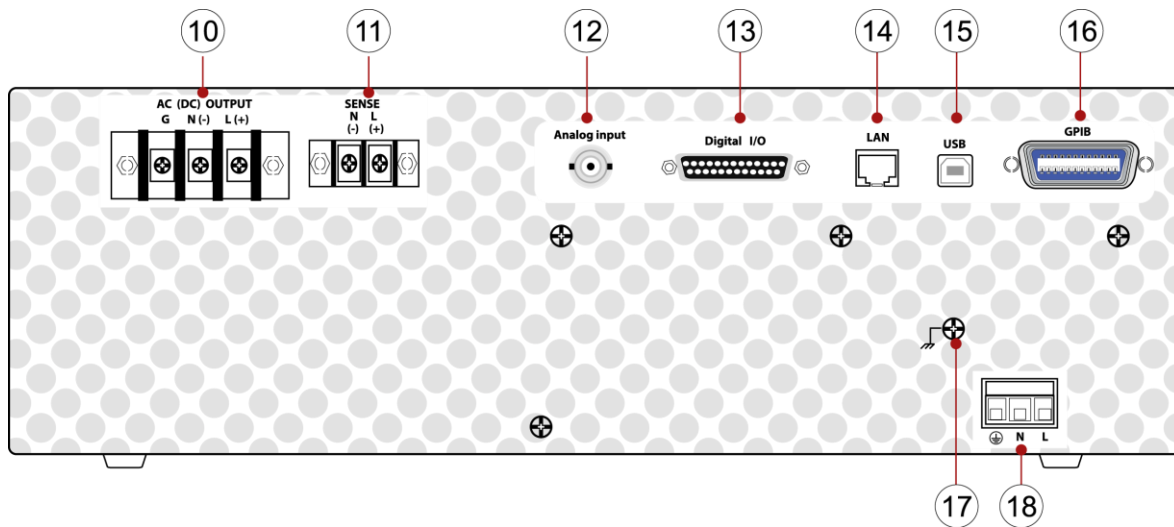

Figure 4 - Rear Panel

- 
- ⑩ AC output terminal

---

  - ⑪ Remote sense terminal

---

  - ⑫ ANALOG connector

---

  - ⑬ DIGITAL Input /Output

---

  - ⑭ LAN port

---

  - ⑮ USB port (USBVCP or USBTMC)

---

  - ⑯ GPIB port

---

  - ⑰ Ground wire

---

  - ⑱ AC input terminal
-

## 4 Display Overview

The power on screen shows the model number and self-test status. The Interface, and Power module should indicate OK. The (Real Time Clock), RTC will show the battery voltage. When the self-test completes, the instrument will advance to the Settings and Measure screen. This process takes approximately 7 seconds. If an error does occur, the instrument must be returned for service.

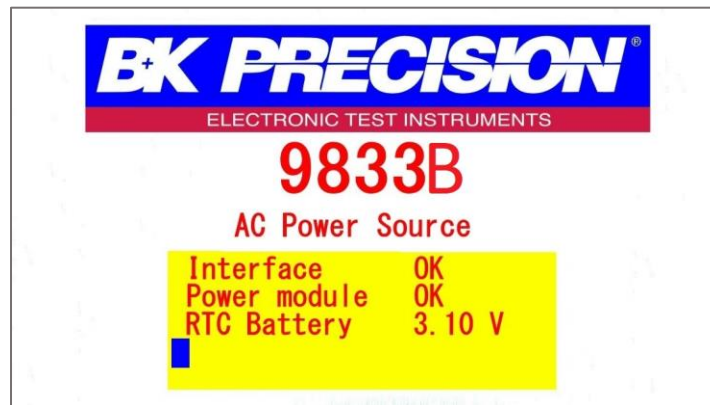

Figure 5 - Power on screen

### 4.1 Display Description

At the top right of the screen the remote and output status are displayed. Each of the blue softkeys will have a corresponding label to the left. These labels will change on each screen to show different options. Settings Fields have a black background. Settings Fields can be selected by using arrow keys to move to the field and press enter to select and modify the value in the field. Press the **Enter** key again to confirm the change or press the **Esc** key to cancel the change.

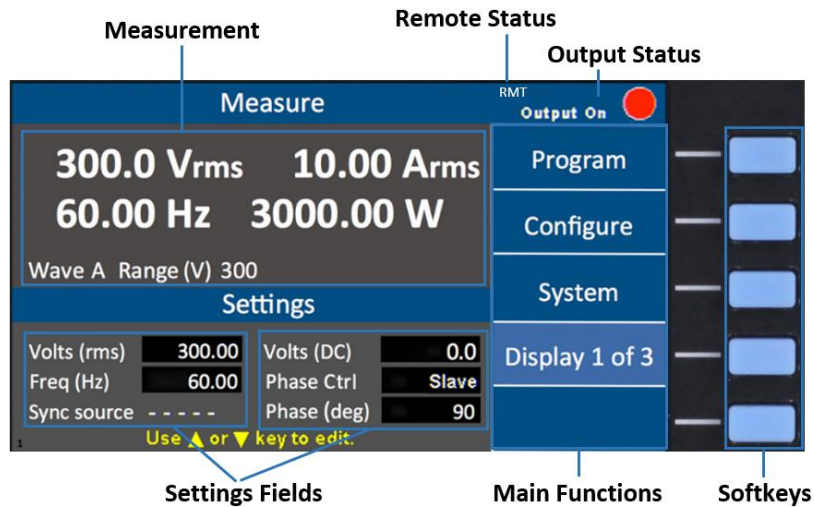

Figure 6 - Display Description

The instrument provides 3 display screen options for accessing commonly used measurements and settings. Each of these screens can be selected by pressing the **Display x of x** softkey repeatedly.

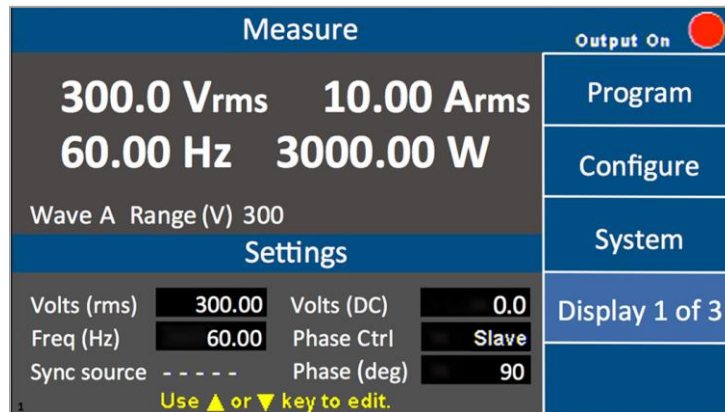

Figure 7 - Display 1 of 3

Parameter	Description
Volts (rms)	AC output Vrms setting
Volts (DC)	DC output setting
Freq (Hz)	Output frequency setting
Sync source	Select Phase or Immed (immediate)
Phase Ctrl	Set 'Master' or 'Slave' for 3-phase operation
Phase (deg)	Phase angle setting

Table 1 – Display 1 of 3 Settings

### Display 2 of 3

This display shows all 12 power measurements and an output timer.

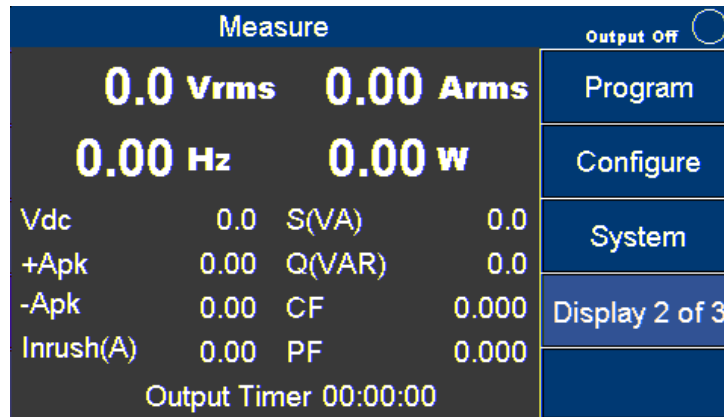

Figure 8 - Display 2 of 3

### Display 3 of 3

This displays shows a graphical representation of the settings, output measurements and waveforms.

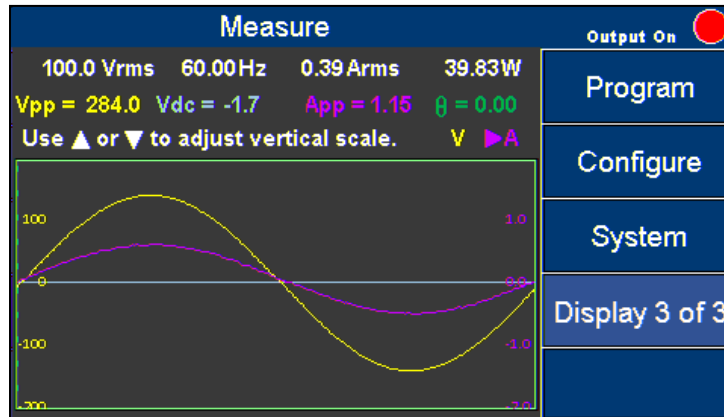

Figure 9 - Display 3 of 3

Press the   keys to select and view V (voltage waveform) or A (current waveform). Then press the   key to change the scale until the complete waveform is visible.

## 5 Getting Started

Before connecting and powering up the instrument, please review and go through the instructions in this chapter.

### 5.1 Input Power Requirements

The AC input accepts line voltage input within:

Voltage: 190 V – 250 V

Frequency: 47 Hz – 63 Hz

Maximum power consumption: 9832B: **2500 VA**; 9833B: **3800 VA**

Before connecting to an AC outlet or external power source, make sure that the power switch is in the OFF position and verify that the AC power cord, including the extension line, is compatible with the rated voltage/current and that there is sufficient circuit capacity for the power supply.

Follow the illustrations below to connect the new AC power cord to the AC input of the source in the rear panel.

---

**CAUTION**

Connection of the 9832B or 9833B to an AC power source should be made by a qualified electrician or other qualified personnel. Incorrect wiring may damage the source or cause a fire hazard.

---

---

**CAUTION**

The included AC power cord is safety certified for this instrument operating in the rated range. If an extension cable is added, be sure that it can meet the required power ratings for this instrument. Any misuse with wrong or unsafe cables will void the warranty.

---

#### 5.1.1 North American Split Phase Power

Split phase is commonly used in North American to provide 208 to 240 Volts. This requires two wires that are both hot. For example 110 V and, 110 V resulting in 220 V across them. The included cable may be used in most regions by adding a band of blue electrical tape on each end of the white wire to identify both the black and white with blue band as hot. The green trace yellow wire is always used for ground and must be connected properly. Check with your local Authority Having Jurisdiction for clarification.

The power cable that is shipped with the instrument is preassembled from the factory. The following instruction will provide information for changing the power cable for split phase.

1. Verify that the source power in your facility can provide the minimum voltage and

current required to operate the instrument.

2. Using the power cable provided, identify the end that plugs into the instrument.

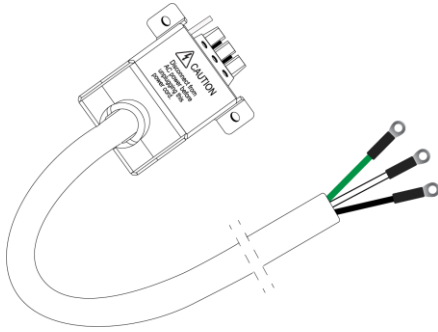

Before disassembling the black hooded connector, make a note of how the unit is assembled from the factory so it can be correctly reassembled.

3. Remove the 4 screws from the bottom of the hooded connector as shown and place the upper and the upper and lower hood pieces and screws to the side.

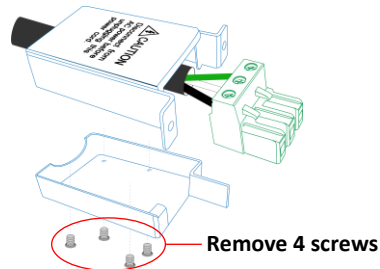

The black, white, and green wires should now be clearly visible. Use a screwdriver to unscrew and release the white wire only.

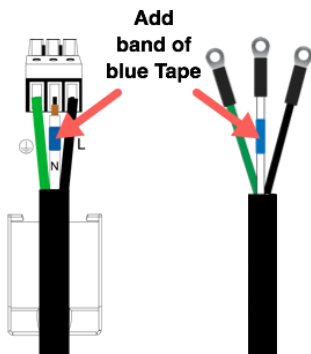

*Add a band of blue electrical tape or heat shrink to each end of the white wire.*

1. Return the white wire into the green connector and tighten the screw. Verify all three wires are secured in the connector.
2. Closely inspect each of the wires at the enter point of the green connector to verify none of the copper strands are bridging over to the wrong terminal causing a short.
3. Carefully reassemble the hood so the Latch Fingers and Caution Label are facing



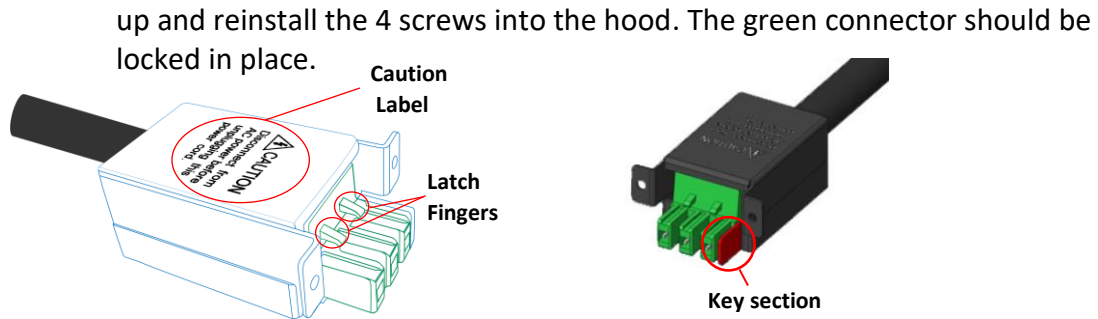

- Using the (2) screws provided with the cable, secure the assembled connector to the back of the instrument as shown in Figure 10 – Securing. Note: Use only the screws provided.

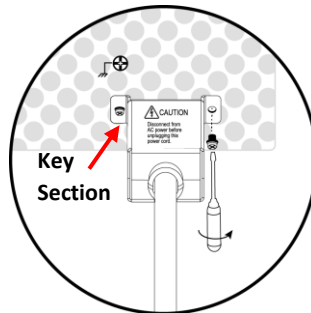

Figure 10 - Securing the power cable

The green (trace yellow) wire connects to electrical ground (required). The black wire connects to L (Line 1) and the white with blue band connects to N (Line 2).

### 5.1.2 Fuse

The factory installed fuse will meet the requirements when the instrument is operated with the specified Input Power requirements. This source is a switching mode power supply. The fuse installed inside should not fail under normal operation. If the fuse has blown, it may be an indication of a more serious malfunction inside of the source. In this event, contact B&K Precision.



**Any disassembling of the case or fuse changes not performed by an authorized service technician will void the warranty of the instrument.**

## 5.2 Preliminary Check

### 5.2.1 Power-on Procedure

- Complete the following steps to verify that the source is ready for use.
- Verify AC Input Voltage
- Verify and check to make sure proper AC voltages are available to power the

instrument. The AC voltage range must meet per the acceptable specifications.

4. Connect Power
5. Connect specified AC power cord and verify the hood is in place and correctly secured to rear panel.



6. Press the power switch to the “|” ON position to turn ON the instrument. It will take a few seconds before the fans power on and the self-test begins.

### 5.2.2 Warm-up Time

The 9830 series is fully operable upon switching the power on. However, to reach the specified equipment accuracy, please allow the source to warm up for at least 15 minutes.

### 5.2.3 Power-off Procedure

When the instrument is not in use, make sure to set the front panel power switch to the OFF position. After the power switch is turned off the internal fans will continue to run for approximately 5-10 seconds to discharge the internal capacitors per safety requirements. Once the discharge process is complete, the instrument will carry out an automatic shutdown process of approximately 2-8 seconds. Do not turn the power back on until the instrument has completed a full shut down cycle.

---

**CAUTION**

Do not connect multiple power supplies in series or parallel as this may cause damage or a malfunction.

---

**CAUTION**

When the AC input voltage is lower than 190 VAC, the source will activate an inner over temperature protector and cut off the output in response to the condition. To ensure that the entire test process can be completed smoothly, confirm that the input AC voltage is within the specified range.

---

**CAUTION**

When the AC input frequency is outside the range of 47 to 63 Hz, the source will beep. To ensure the normal operation of the source, please make sure the AC input frequency is within the required range.

---

## 5.3 Sense Lines

The source can be configured as local sense or remote sense to compensate the voltage drop of the test leads. The following diagram shows how to connect the load by local sense or remote sense configurations.

When local sense is selected, the sense end L is connected to the output end L and sense end N is connected to the output end N, whereas the output end L is connected to the load end L and output end N is connected to the load end N. When this sensing mode is selected, the wires connecting between the sense ends to the load end must be

as short as possible. The local sense is the default configuration. When remote sense is selected, both the sense end L and output end L are connected to the load end L, whereas both sense end N and output end N are connected to the load end N.

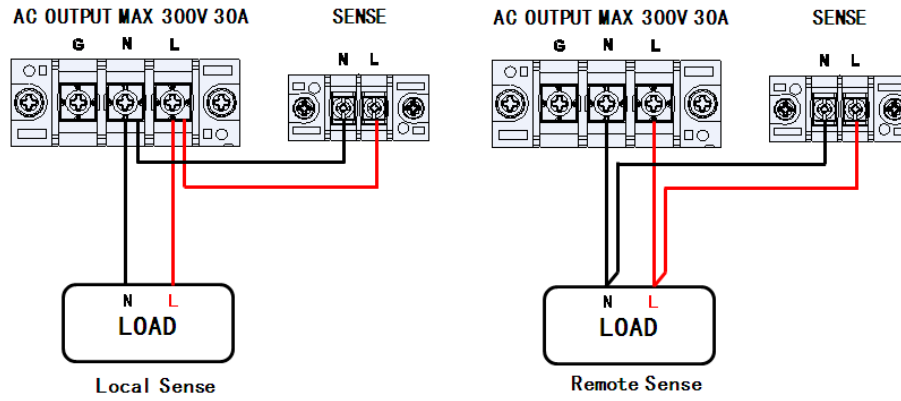
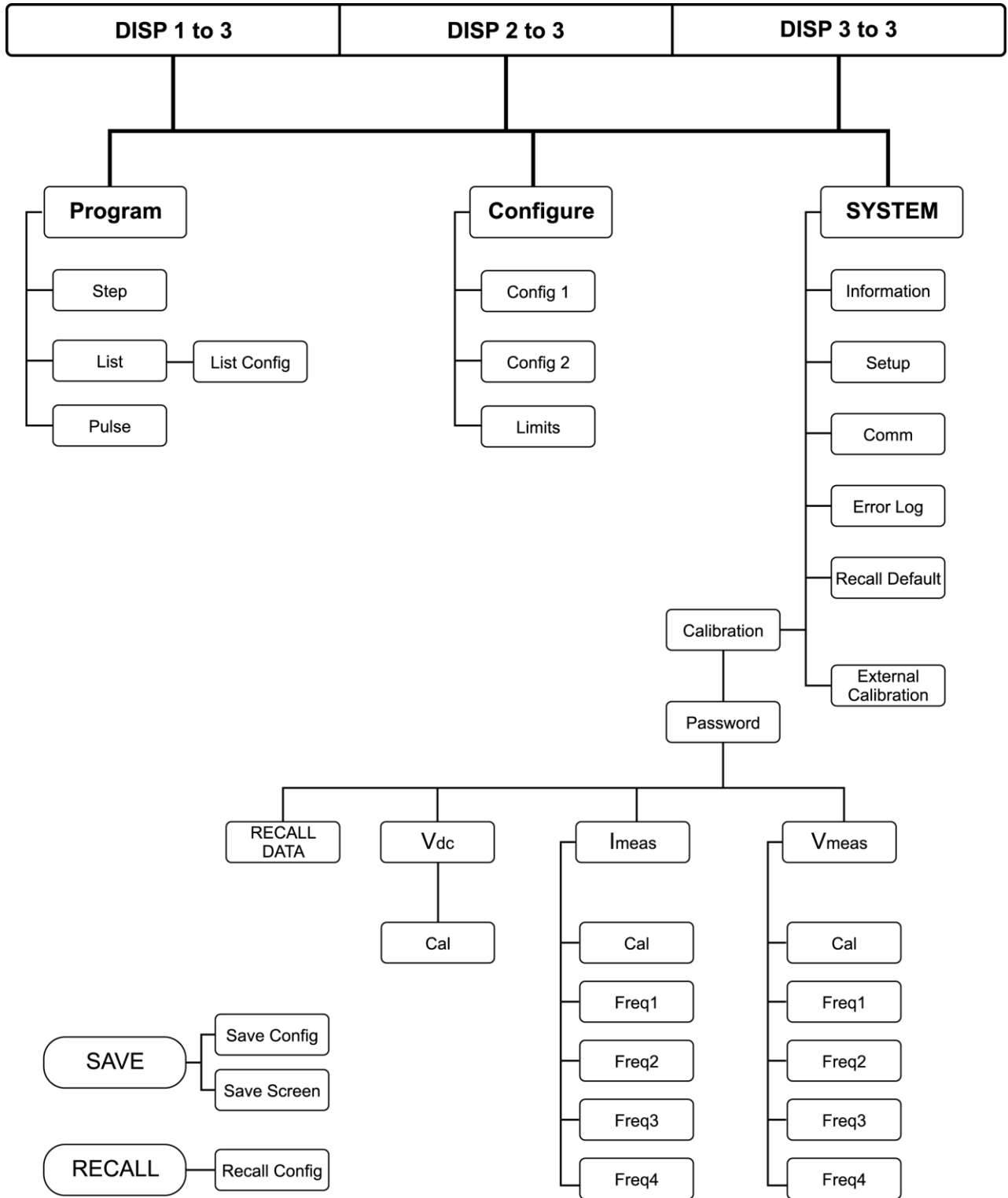

Figure - 11 Sense Lines

# 6 Menu Tree



## 7 Front Panel Operation

### 7.1 Configure Voltage and Frequency Output

#### 7.1.1 Setting voltage

Press **VOLT** or the **▲ ▼** (arrow keys) to move the cursor to **Volts (rms)**. Then press the **ENTER** key.

There are three ways to set the value of the output voltage:

1. Press the number keys **1**, **1**, **0**, **.**, **0** and **Enter** to set Volts(rms) = 110.0 V.
2. Use the **◀ ▶** keys to select the hundreds digit then press the arrow keys **▲** or **▼** repeatedly until the value reaches 110.0 and press the **Enter** or **OK** key to confirm.
3. Use **◀ ▶** keys to the hundreds digit then use the rotary knob until the value reaches 110.0. Press the **Enter** or **OK** key or push in on the rotary knob to confirm.

#### 7.1.2 Setting frequency

Press **FREQ** or arrow key (**▲ ▼**) to move the cursor to the **Freq (Hz)**. Then press the **ENTER** or **OK** key.

There are three ways to set the value of output frequency:

1. Press number key **6**, **0**, **Enter** or **OK** to set Freq (Hz) = 60.
2. Use **◀ ▶** keys to the hundreds digit then press arrow keys (**▲** or **▼**) repeatedly until the value reaches 60. Press **Enter** or **OK** key to confirm.

Use **◀ ▶** keys to select the hundreds digit then rotate the rotary knob until the value reaches 60. Press **Enter** or **OK** key or press in on the rotary knob to confirm the change.

---

#### NOTES:

- 1) The values of some settings are strings, for example, Sync Source = IMMED (or PHASE). These settings can be set by the arrow keys (**▲ ▼ ▶ ◀**) or the rotary knob.
  - 2) When the output status is ON, any changes to the displayed values of Volts(rms), Volts(DC) or FREQ are immediately reflected at the output.
  - 3) Except for Volts(rms), Volts(DC) and FREQ, the **ENTER** key must be pressed to confirm the new output value and save the new settings to memory. Changes can be cancelled by pressing the **ESC** key before the **ENTER** key.
-

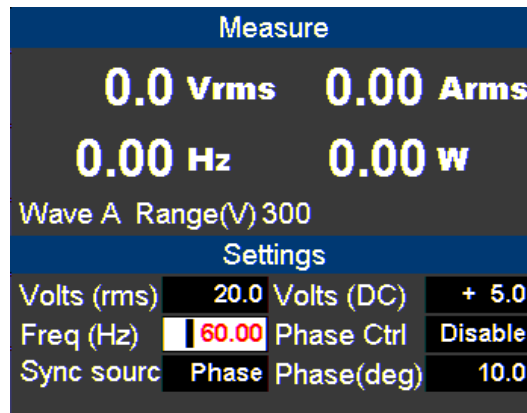

Figure 12 - Setting Frequency

### 7.1.3 Setting Voltage

Press the **VOLT** key, and a small window will pop-up. Pressing the **VOLT** key again will switch between VAC and VDC (when the coupling mode is "AC+DC"). Press the number keys to set the value, and press the **OK** or the **Enter** key to confirm the change. Optionally, press the **ESC** key to cancel the setting change.

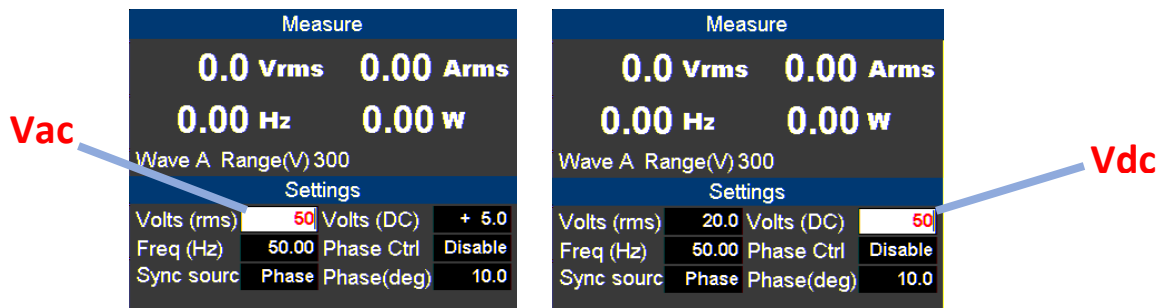

Figure 13 - Setting Voltage. Vac left, Vdc right.

## 7.2 Program Settings

Press the **Program** softkey in the Setting and Measurement page to enter Program mode. There are three modes for the user to choose from to simulate Power Line Disturbances. They are:

**Step** Output settings step-up or step-down based on user criteria.

**List** Change the output sequentially by individual settings included in a list.

**Pulse** Trigger pulse signals periodically.

### 7.2.1 Step Mode

Step Mode has 10 parameters that can be set by the user. The following table describes each parameter with its range and description.

Parameters	Range	Description
Volts (rms)	0 to 300.0 Vrms	Initial AC output voltage
dVac	0 to $\pm 300.0$ Vrms	In/decrement of VAC per step
Volts (DC)	-424.0 to 424.0 V	Initial DC output voltage
dVdc	-424.0 to 424.0 V	Increment/decrement of VDC per step
Freq.	43 to 1200.0 Hz	Initial output frequency
dF	$\pm 43$ to 1200.0 Hz	Increment/decrement of FREQ. per step
Set Time	0 to 100000 ms	Set the time interval of one step
Count	1 to 99	Set how many steps to run
Sync Source	Immed, Phase	Select the mode of output transient phase
Phase (deg)	0.0 ° to 359.7 °	Set the angle of output transient

Table 2 - Step Mode Parameters

## Step Mode Operation Steps

The following example for Step Mode waveform shows 4 steps starting at 40 volts and increasing 20 volts at each step. The instrument will dwell for 80 ms at each step.

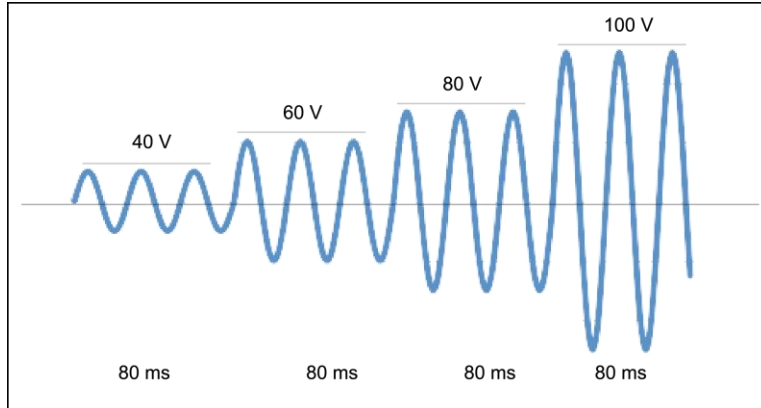

Figure 14 - Step Mode Example Output

Parameters	Settings
Volts(rms)	40
dVac	+20
Volts(DC)	+0
dVdc	0
Freq.	50
dF	0.0
Set Time	80
Count	4
Sync Source	Phase
Phase(deg)	0.0

Table 3- Step Mode Example Parameters

Press the **Step** softkey.

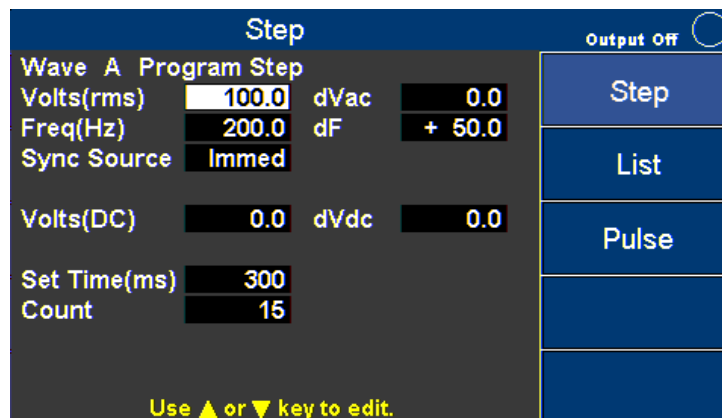

Figure 15 - Step Page



1. Use the arrow keys (**▲** **▼** **◀** **▶**) to move the cursor to the wanted parameter of the STEP setting page.
2. Press the **ENTER** key to adjust the parameter. Then press the **ENTER** key again to change its value.
3. When finished editing all the parameters, press **On/Off** key to activate the Step mode.

Using an oscilloscope you should observe a wavfore as shown in Figure 16 - Oscilloscope view of Step waveform example.

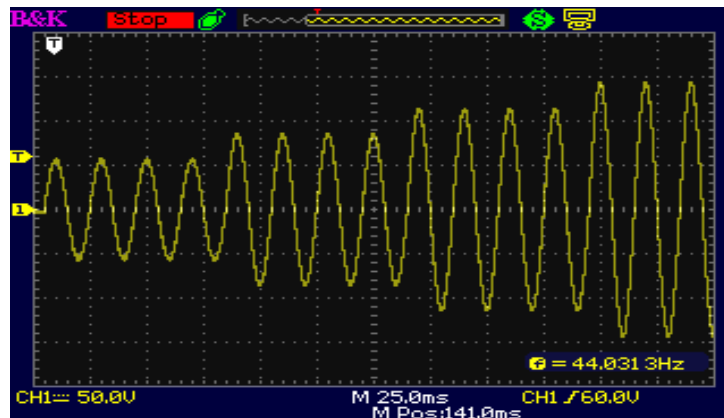

Figure 16 - Oscilloscope view of Step waveform example

The instrument will continuously output the final waveform of Step mode until the **On/Off** key is pressed.

### 7.2.2 List Mode

List mode is the only mode with two pages of parameters. The first page of parameters is common to all the Second page parameters. Only one first page is needed per list. The first page, Table 4 - List Parameters, First Page is displayed when the **List** softkey is pressed and the second page, Table 5 - List Config Parameters, Second Page is displayed when the **List Config** softkey is pressed.

Parameters	Range	Description
List	0 to 9	Index of LIST
Infinite	ON or OFF	ON: Infinite output OFF: Based on Repeat value
Repeat	0 to 99	Repeat sequence
Base	Time or Cycle	Select the unit for timing the running of LIST
Sync Source	Immed or Phase	Select the mode of output transient phase
Phase (deg)	0.0 to 359.7	Set the angle of output transient

Table 4 - List Parameters, First Page

Parameters	Range	Description
List No.	0 to 9	Show configuration of a LIST
Step No.	0 to 99	Show current edit step of list
Volts (rms) Start	0 to 300	Set starting AC voltage
Volts (rms) End	0 to 300	Set ending AC voltage
Volts (DC) Start	-424.0 to 424.0	Set starting DC voltage
Volts (DC) End	-424.0 to 424.0	Set ending DC voltage
Freq. (Hz) Start	43 to 1200.0	Set starting frequency
Freq. (Hz) End	43 to 1200.0	Set ending frequency
Time (ms)	0 to 999999	Set the time interval for running the specified configuration
CYCLE	0 to 999999	Set the period for running the specified configuration
Steps	0 to 200	Set the number of steps the specified configuration will be divided into

Table 5 - List Config Parameters, Second Page

In the following example 3 new steps will be added to List No. 0.

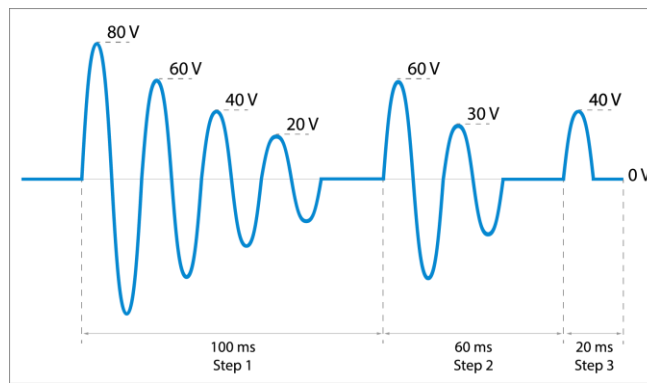

Figure 17 - List Mode Waveform

Parameters	Step 1	Step 2	Step 3
List No.	0	0	0
Step No.	0	1	2
Volts (rms) Start	80	60	40
Volts (rms) End	0	0	0
Volts (DC) Start	0	0	0
Volts (DC) End	0	0	0
Freq. (Hz) Start	50	50	50
Freq. (Hz) End	50	50	50
Time (ms)	100	60	20
Steps	5	3	2

Table 6 – Step parameters

## List operation pages

Press the **List** softkey, refer to List Parameter Table for settings details.

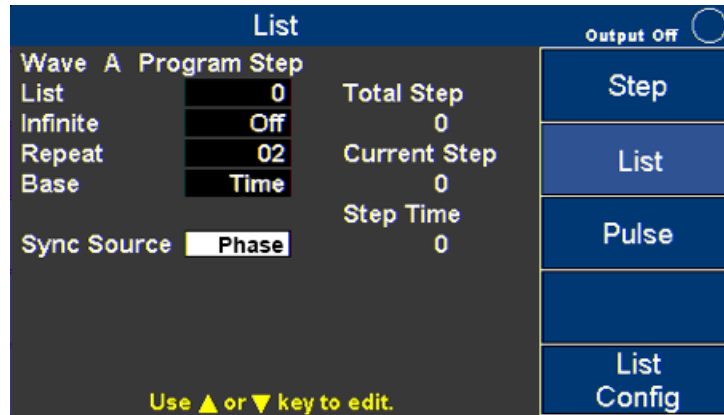

Figure 18 - List Mode first page

Refer to Table 6 – List Mode First Page. The first page parameters are common to all the steps added under the second page parameters. This first page only needs to be configured once for List 0. Use the arrow keys (▲▼◀▶) to move the cursor to the wanted parameter of the List page. Then press the **ENTER** Key to change its value. Configure all the parameters for the List mode first page.

Parameters	Example Settings
List	0
Infinity	OFF
Repeat	02
Base	Time
Sync Source	Phase
Phase (deg)	0.0

Table 7 - List Mode First Page

When all of the values for the First page have been configured, press **List Config** softkey to move to the Second page. The Step No. will indicate “New” as the values have not been stored in memory yet. Empty Step 100 and current Step 0 will be indicated in the



. Use the arrow keys (**▲** **▼**) to move the cursor to the wanted parameter of List Step Configuration page. Press the **ENTER** key to change its value, then press the **ENTER** key again to confirm the change.

Parameters	Values
Volts (rms) Start	60
Volts (rms) End	0
Volts (DC) Start	0
Volts (DC) End	0
Freq. (Hz) Start	50
Freq. (Hz) End	50
Time (ms)	60
Steps	3

Figure 21 - List 0, Step 2 Values

After all of the values have been entered, press the **Add Step** softkey to enter these changes in to memory and add a new step in List No. 0. The page with Empty Step field in yellow will change to 98 and Current Step to 2.

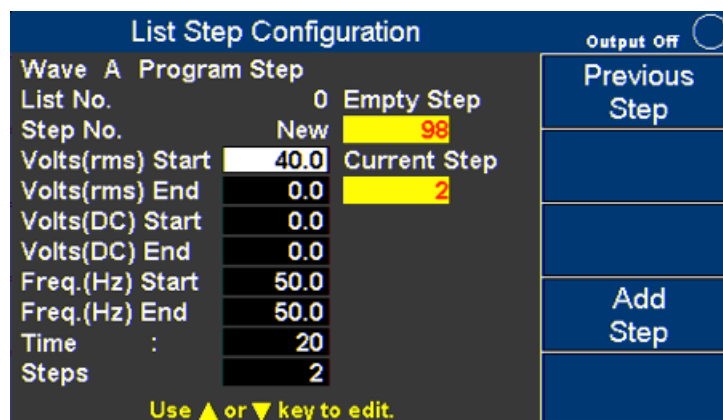

Figure 22 - Add New Step

Parameters	Settings
Volts (rms) Start	40
Volts (rms) End	0
Volts (DC) Start	0
Volts (DC) End	0
Freq. (Hz) Start	50
Freq. (Hz) End	50
Time (ms)	20
Steps	2
Volts (rms) Start	40
Volts (rms) End	0

Table 8 - List Mode Parameters

After all of the values have been entered, press the **Add Step** softkey to enter these

changes in to memory and add a new step in List No. 0. The page with Empty Step field in yellow will change to 97 and Current Step to 3. All of the steps 0, 1 and 2 have been entered.

Press the **ESC** key to exit. Make sure Set Repeat is = to 1 and press **On/Off** key to activate the List mode.

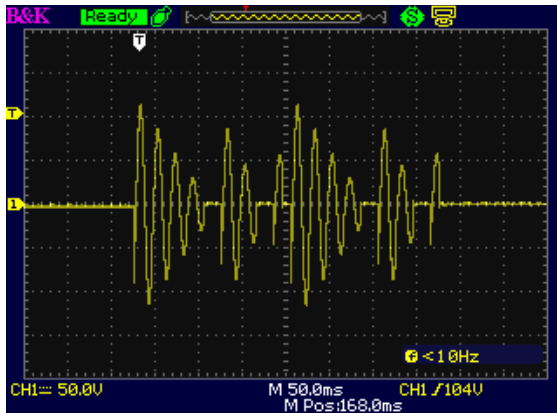

Figure 23 - Oscilloscope view of List mode waveform example

### 7.2.3 Pulse Mode

The following example will describe how to setup the Pulse Mode.

Parameters	Range	Description
Volts (rms)	0 to 300.0 Vrms	Set the AC voltage of a pulse
Volts (DC)	-424.0 to 424.0 V	Set the DC voltage of a pulse
Freq.	43 to 1200.0Hz	Set the frequency of a pulse
Duty	0 to 100.0 %	Set the duty cycle for the pulse holding (% of period time)
Period	0 to 100000ms	Set the pulse to pulse period
Count	1 to 99	Set how many pulses to generate
Sync Source	Immed, Phase	Select the mode of output transient phase
Phase	0.0 ° to 359.7 °	Set pulse phase angle

Table 9 - Pulse Mode Parameters	Settings
Volts (rms)	100
Freq.	50
Duty (%)	25
Period(ms)	80
Count	4
Sync Source	Phase
Phase (deg)	90

Table 10 – Pulse Mode Settings

## Pulse Mode Operation Steps

1. Press **Pulse** softkey.
2. Use the arrow key (**▲** **▼**) to move the cursor to the wanted parameter.
3. Press the **ENTER** key to change its value then press the **ENTER** key again to confirm.

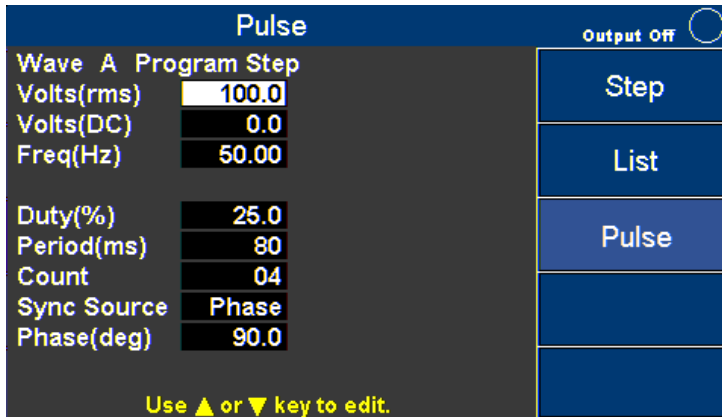

Figure 24 - Pulse mode page

4. When finishing editing the parameters press the **On/Off** key to active the Pulse mode.

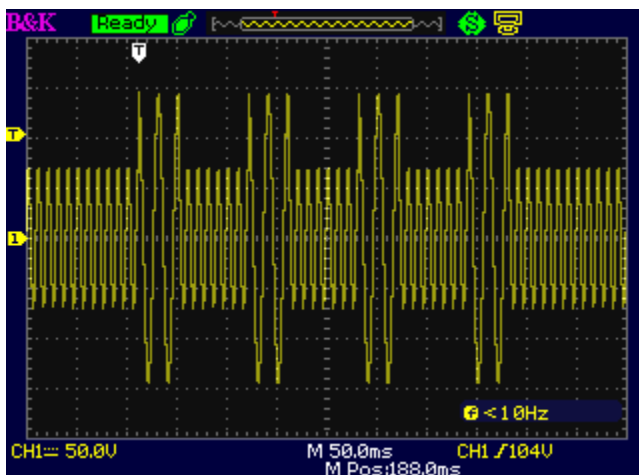

Figure 25 - Oscilloscope view of Pulse waveform example

## 8 Configure Menu

In Setting and Measure page, press **Configure** key to open the Configuration page. The Configuration page includes three softkey options:

1. Config 1 (default)
2. Config 2
3. Limits

Each of these pages will be explained below with more detail.

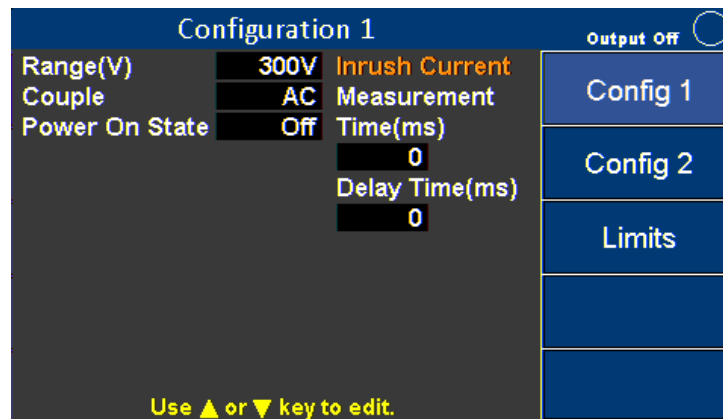

Figure 26 - Default Configuration 1 Menu

### 8.1 Config 1

Configurations listed below can be edited in this Configuration 1 page.

Configurations	Range	Description
Range	150 V, 300 V	Select the range of AC output voltage
Couple	AC, DC or AC+DC	Select the coupling of output voltage
Power On State	OFF, LAST, USER	OFF: When power on, the output is OFF. LAST: When power on, the settings will restore to the pre-shutdown state. USER: When power on, users need to set the output value and status. (Volts(rms), Volts(DC), Freq, Sync Source )
Inrush Current Measurement Time (ms)	0 to 10000 ms	Set the time interval to measure Inrush current
Inrush Current Delay Time (ms)	0 to 10000 ms	Set the delay time to measure Inrush current

Table 11 - Config 1 Configurations



Press the arrow key (▲▼) to move the cursor to the wanted configuration. Press **ENTER** key to change its value, then press **ENTER** key to confirm.

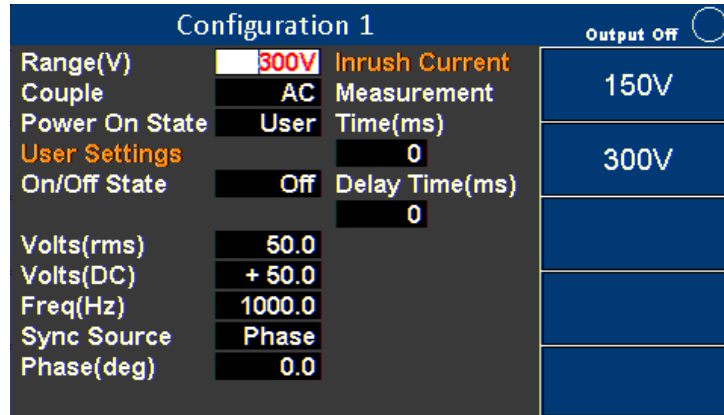

Figure 27 - Configuration 1

Move the cursor to Range (V) then Press **ENTER** key. Press **300 V** key to put the supply in the high voltage range, then press **Enter** key to confirm.

Or use ▲▼ keys (or Rotary) to set the value of Range (V) and other configurations. Use ▲▼ keys (or Rotary) to choose other configurations.

## 8.2 Config 2

Configurations listed below can be edited in Configuration 2 page.

Configurations	Range	Description
Waveform Select	A or B	Select to output waveform A or B
Waveform A Type	SINE, SQUA, CSIN (clipping sine), THD0-29 (harmonic distortion sine), USER0-4 (user designed waveform)	** SQUA, CSIN (clipping sine), THD (harmonic distortion sine), USER (user define waveform) only for Frequency $\leq 100\text{Hz}$
Waveform A Index (waveform A clip level (%))	0-29 (0.0 to 100.0%)	When waveform A is THD, set index When waveform A is CSIN (clipping sine), set the clip level %
Waveform B Type	SINE, SQUA, CSIN (clipping sine), THD0-29 (harmonic distortion sine), USER0-4 (user design waveform)	** SQUA, CSIN (clipping sine), THD (harmonic distortion sine), USER (user define waveform) only for Frequency $\leq 100\text{Hz}$
Waveform B Index (waveform B clip level (%))	0-29 (0.0 to 100.0%)	When waveform B is THD, set index When Waveform B is configured as a CSIN (clipping sine), set the clip level %

Output Timer	ON or OFF	Enable/disable the output timer. Note: This function is available in display 2 of 3 only.
Timer Setting (H/M/S)	0 to 99 (hours) : 0 to 59 (minutes): 0 to 59 (seconds)	Set the timing interval of output timer. When the output is turned on the timer will count down to 0 and turn the output off.
External Ref.	OFF or LEVEL or AMP	Enable/disable the input of the external reference signal OFF: Function disable. LEVEL: Input DC reference voltage (0 to ±10 V) via the digital IO connector to control output voltage. AMP: Input reference waveform to BNC connector (-6 to +6 V) to control output waveform. Note: If the input frequency is over 1200 Hz, the amplitude of output will diminish.
Remote Inhibit	ON or OFF	Remote shutdown function.
Transient	ON or OFF	When output voltage is changed, the instrument will output a pulse signal on “Trans” at the digital I/O terminal.

Press the arrow key ( $\blacktriangle$   $\blacktriangledown$ ) to move the cursor to the wanted configuration. Press the **ENTER** key to change its value then press the **ENTER** again key to confirm.

See the example below:

Move the cursor to Waveform Select, then press **OK** or **Enter**. Press the **A** softkey then press **OK** or **Enter** to confirm. Use  $\blacktriangle$   $\blacktriangledown$  keys (or Rotary knob) to select the other configurations.

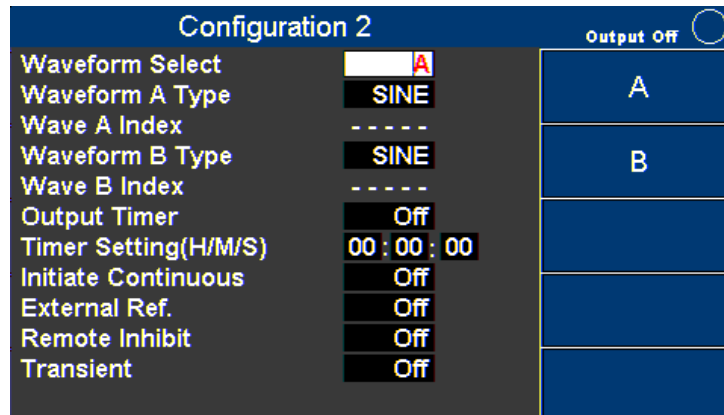

Figure 28 - Configuration 2 page

### 8.3 Limits

The Configuration Limits page is used to set user-defined voltage, current and power limits.

Configurations	Range	Description
Volts (rms)	0.0 to 306.0 Vrms	Set the limit value of AC output voltage
Volts (Vp) +	0.0 to 427.0 V	Set the limit value of positive DC output voltage
Volts (Vp) -	-427.0 to 0.0 V	Set the limit value of negative DC output voltage
A	0.00 to 33.00 A	Set the limit value of AC output current
A Delay (ms)	0 to 10000 ms	Set the time delay to activate protection when the current limit is reached
Power	0 to 3300.00 VA	Set the limit value of output power

Table 12 - Limits descriptions

Press the arrow key ( $\blacktriangle$   $\blacktriangledown$ ) to move the cursor to the wanted configuration. Press  $\text{ENTER}$  key to change its value, then press  $\text{ENTER}$  key to confirm.

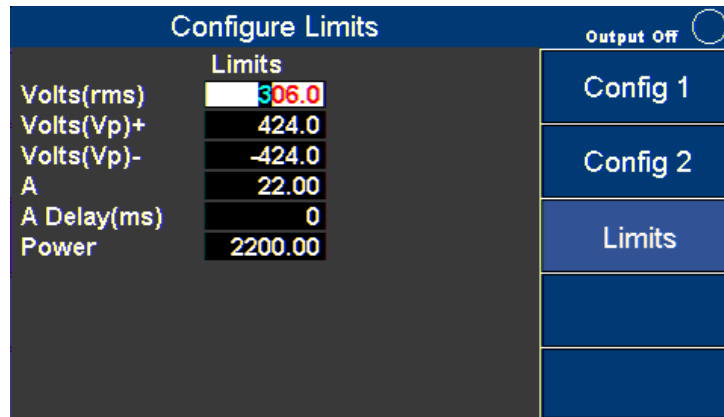

Figure 29 - Configure Limits

Move the cursor to Volts (rms). Use  $\blacktriangle$   $\blacktriangledown$  keys (or Rotary knob) to set the value of Volts (rms) limit and other configurations. Then press  $\text{OK}$  or  $\text{Enter}$  key to confirm this setting.

Use  $\blacktriangle$   $\blacktriangledown$  keys (or Rotary knob) to select other configurations.

---

**NOTE: If the output exceeds the limit value the Instrument will stop and the output will display an error message. Press the  $\text{ESC}$  key to close the message window.**

---

## 9 System Settings

### 9.1 System Setup

The System Setup page is used to set Date, Time, Brightness and Beep.

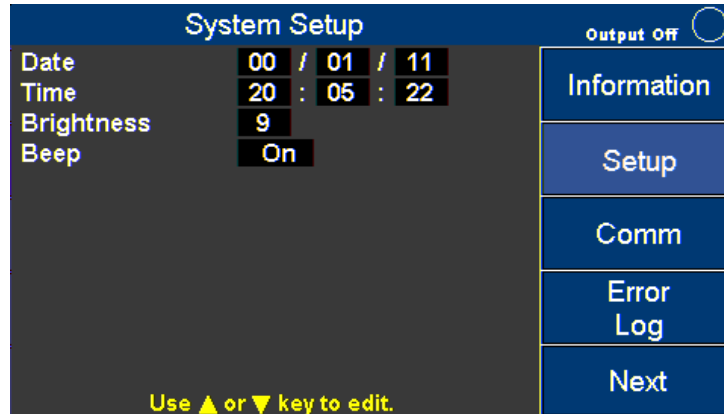

Figure 30 - System Setup

Press the arrow keys (**▲** **▼**) to move the cursor to the wanted configuration. Press the **ENTER** key to change its value and then press the **ENTER** key again to confirm the changes.

Configurations	Range	Description
Date	YY/MM/DD	Set the date (year/month/day)
Time	HH:MM:SS	Set the time (hour/minute/seconds)
Brightness	0 to 9	The level of the LCD brightness
Beep	ON or OFF	Enable/disable the buzzer

Table 13 - System Setup Configurations

## 9.2 Communication Setup

The Communication Setup page is used to select and configure the communications ports.

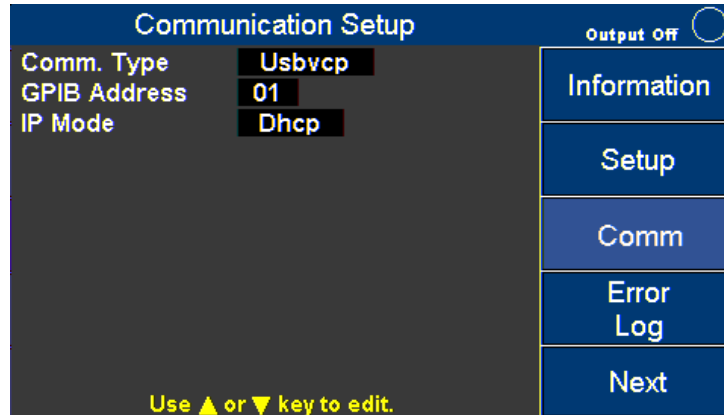

Figure 31 - Communication Setup

Press the arrow keys (**▲** **▼**) to move the cursor to the wanted configuration. Press the **ENTER** key to change its value and then press the **ENTER** key again to confirm the changes.

Configurations	Range	Description
Comm. Type	USBVCP, USBTMC, GPIB, LAN, RS232	USBVCP: USB Virtual Com Port (19200, N, 8, 1) USBTMC: USB Test and Measurement Class. <i>(NI VISA Driver is needed)</i> GPIB: General-Purpose Interface Bus LAN: Local Area Network RS232: (On Digital I/O board 19200, N, 8, 1)
GPIB Address	1 to 30	Set the GPIB address
IP Mode	DHCP (Auto), Manu, (STATIC)	Select how to assign the IP. DHCP: Auto assigns IP. Manu: Assign IP address, subnet mask, and gateway manually.
IP Address	XXX : XXX : XXX : XXX	IP address
Subnet Mask	XXX : XXX : XXX : XXX	Subnet mask
Gateway	XXX : XXX : XXX : XXX	Gateway

Table 14 - Communication Configurations

### 9.3 System Error

The System Clear Error page is used to view and clear the error log. Use   key or rotary knob to see other error messages.

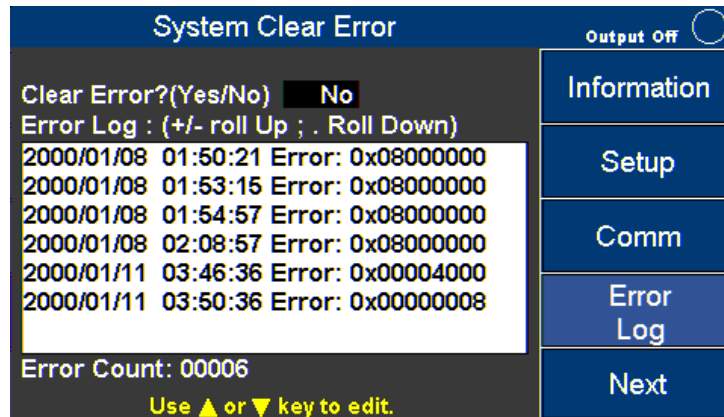

Figure 32 System Error Log

To clear the error log Press the arrow key ( ) to move the cursor to Clear Error? (Yes/No) then press the  key to change its value. Select YES, then press  key again to clear error log. The log errors cannot be recovered once it has been cleared.

Error Code	Definition
0x00000080	FW_VerError
0x00000040	SW_EShutdown
0x00000020	SW_OVAP Software
0x00000010	SW_OPP Software
0x00000008	SW_OVP
0x00000004	SW_OCP
0x00000002	SW_CAN2Error
0x00000001	SW_CAN1Error
0x00018000	AC Input Fail
0x00040000	HW Over Voltage
0x88E00000	HW Over Current
0x33180000	Over Temperature
0x00004000	FAULT_FAN_FAIL
0x00002000	FAULT_CURR_LIMIT
0x00001000	FAULT_CURR_OVSPEC
0x00000800	AC Input too low
0x00000400	AC Input too high
0x00000200	PFC Vbus too high
0x00000100	AC Input Freq. Error

Table 15 - Error Code Definitions

## 9.4 System Next

The System Next page is used to access to system defaults and calibration functions.

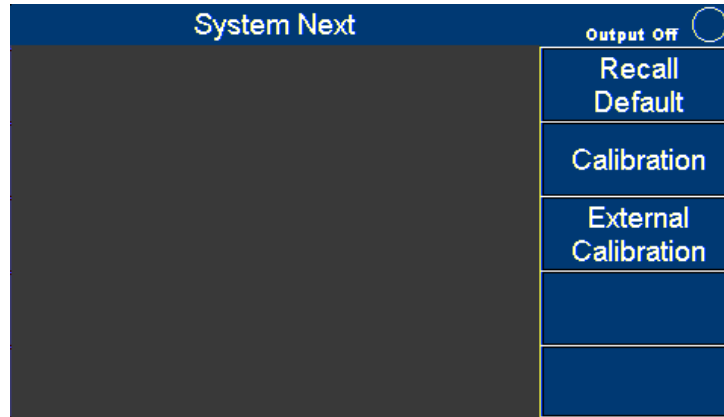

Figure 33 - System Next Page

## 9.5 Recall Default

Press **System** softkey, then press **Next** softkey to go to the next function page. At the System Next screen press **Recall Default** softkey. Press an arrow key (**▲** **▼**) to move the cursor to Reset all config? Press **ENTER** key, then press the **Yes** softkey to reset all configurations.

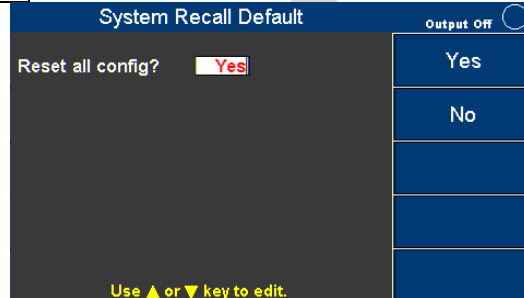

Figure 34 - Recall Default

Config 1(2) Field	Value
Volts (rms)	50
Volts (DC)	0
Freq (Hz)	60
Sync source	Phase
Phase (deg)	0.0
Range(V)	300
Couple	AC
Power On State	Off
(User) On/Off State	Off
(User) Volts(rms)	0
(User) Volts(dc)	0



(User) Freq(Hz)	60
(User) Sync Source	Phase
(User) Phase(deg)	0
(Inrush) Measurement Time(ms)	0
(Inrush) Delay Time(ms)	0
Waveform Select	A
Waveform A Type	Sine
Wave A Index	----, 0
Waveform B Type	Sine
Wave B Index	----, 0
Wave B	Index 0
Output Timer	Off
Timer Setting	--:--:--
External Ref.	Off
Remote Inhibit	Off
Transient	Off

**Table 16 - Default Values**

## 10 Save

The Instrument can save data and screen shots into the USB disk (only FAT format is supported).

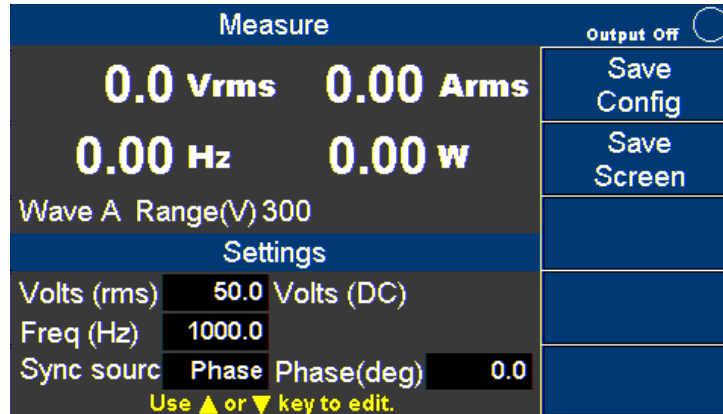

Figure 35 - Save Menu

### 10.1 Save Config

Press **Save Config** softkey to store all configurations and settings into the internal memory (CFGFile01.cfg to CFGFile09.cfg) or into a USB disk (CFGFile10.cfg to CFGFile99.cfg). Use the number keys to enter the file name. Then press **OK** or **ENTER** key to confirm or press **ESC** key to cancel.

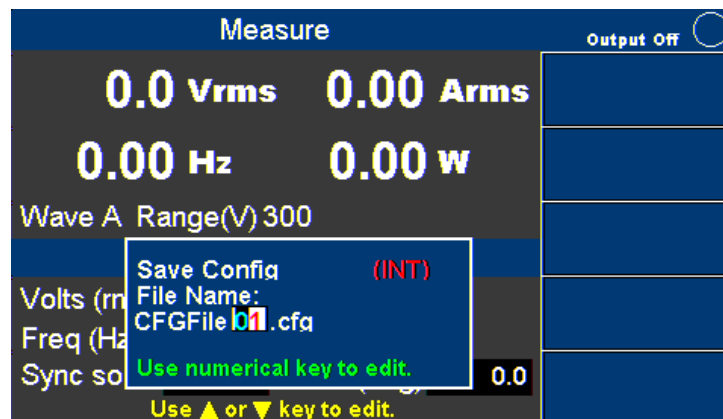

Figure 36 - Save Config

## 10.2 Save Screen

Plug in a USB disk, then press the **Save Screen** softkey to take a screen shot and store the image to a USB disk (SCRFile000.bmp to SCRFile999.bmp). Use number keys to enter the file name. Then press **OK** or **ENTER** key to confirm or press **ESC** key to cancel.

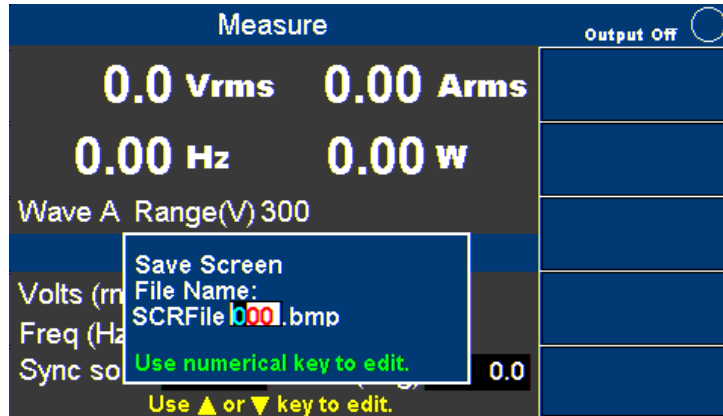

Figure 37 - Save Screen

## 10.3 Recall Configuration

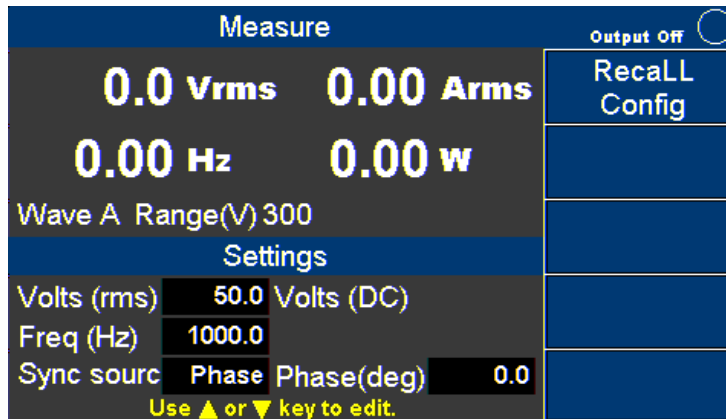

Figure 38 - Recall page

Press **Recall Config** softkey to recall configurations and settings from internal memory (CFGFile01.cfg to CFG09File.cfg) or from a USB disk (CFGFile10.cfg to CFGFile99.cfg).

Use the number keys to enter the file name. Then press OK or ENTER key to confirm, or press **ESC** key to cancel.

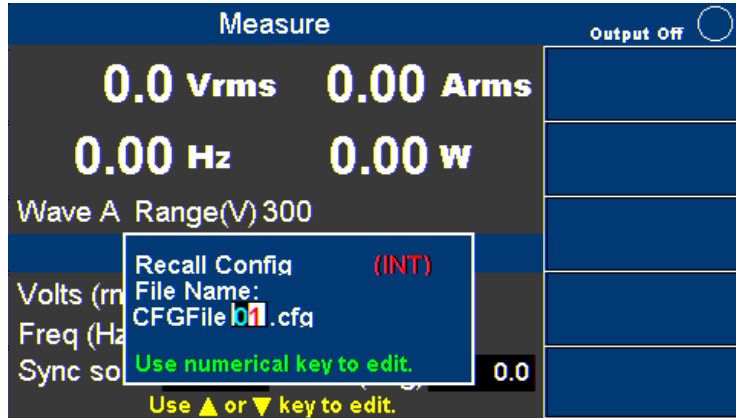

Figure 39 - Recall File Selection

## 11 3-Phase Operation

Three-Phase or Multi-Phase operation requires the three 9832B or 9833B AC sources and the 3-Phase kit (model TL983P-KIT) which includes three phase sync modules and two straight through (pin to pin) RJ45 communication cables for 3-Phase operation. Replacement modules (model TL983P) are sold separately. Additional phases require additional modules and RJ45 communication cables.



3-Phase kit option (TL983P-KIT)

### *Limitations*

9830B Series programming features including step, list, pulse, and amplifier mode are disabled in 3-phase mode. Several configuration settings (Config 1 and Config 2) remain enabled in 3-phase mode. Range, coupling mode, power on state, and inrush current measurement settings can be adjusted in 3-phase mode under the Config 1 menu. Under the Config 2 menu, external reference and transient settings are disabled in 3-phase mode.

### 11.1 Setup and Configuration

The 9830B Series 3-phase operation uses a master/slave configuration. 3-phase operation requires three identical 9832B or 9833B models. One AC source will be set to master with the remaining set to slaves.

#### 1) Rear panel configuration

Power off and disconnect the AC sources from AC input. Connect one TL983P module to the Digital I/O (DB25) bus connector to the rear of each AC source using the included screws and washers to hold them firmly in place. Use a standard Ethernet (RJ45) type connector to daisy chain modules as shown in the following figure.

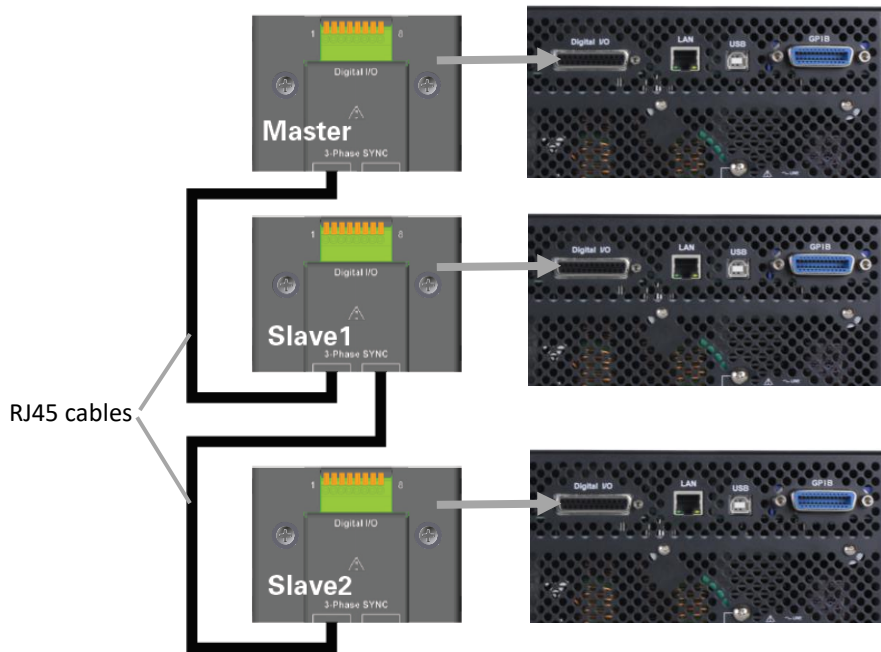

Additional phases require additional AC sources and TL983P modules.

## 2) Front panel configuration

After verifying the TL983P adapters are properly wired on the rear panel, the AC sources must be configured from the front panel. 3-phase operation is enabled by setting the phase control field on each AC source.

The options for phase control are Master, Slave, or Disable. The master must be set first. Any one of the three connected AC sources can be set to master. Use the directional key pad to highlight the phase control field, use the soft key to select master, and press enter to confirm (**Figure 11.1**).

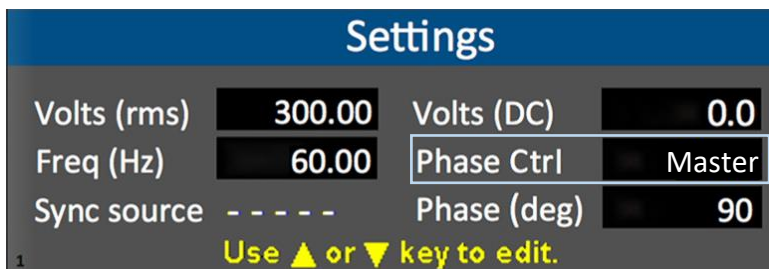

Figure 11.1: Phase control setting



Do not set more than one AC source to 'Master' as this may cause damage or a malfunction.

Similarly, after setting the master set 'Phase Ctrl' of the remaining two AC sources to 'Slave'. The slaves will automatically connect to the master.

This completes the set-up process for three phase operation.

### 3) 3-Phase parameters and output

3-Phase parameters include: Voltage (rms), Frequency (Hz), and Phase (deg). The reference phase of the master is always fixed at 0 degrees. The phase angle of slave sources can be adjusted from 0 to 359.7 degrees.

The coupling mode can be changed to AC+DC in 3-phase mode to add a positive or negative DC offset to the AC signal. The DC offset can be set from -424 V to +424 V.

Output of the system is controlled by the master. Enabling/disabling the output of the master also enables/disables the output of slave instruments.

## 11.2 3-Phase Adapter Digital I/O Pin Definitions

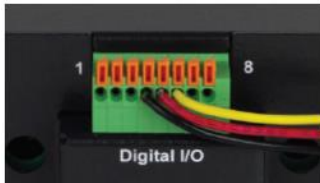

The 8-pin digital I/O terminal block on the rear of the TL983P adapter preserves commonly used signals. See Table 11.2 for the pin definitions. To insert a wire into the digital I/O block: press the orange tab in, insert wire, and release the tab to hold the wire in place.

TL983P Pin	9830B Digital I/O pin	Function
1	23	RX
2	11	TX
3	10	GND
4	19	Remote inhibit
5	4	AC ON
6	16	Fault out
7	Reserved	-
8	Reserved	-

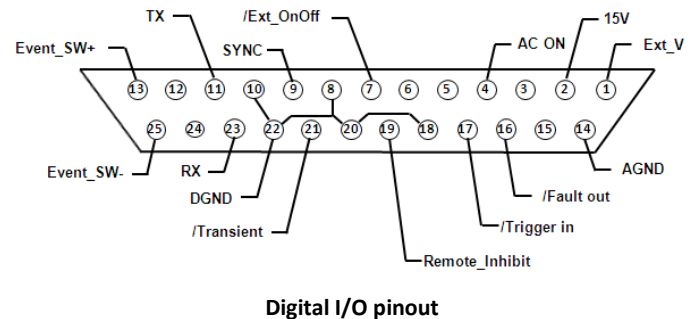
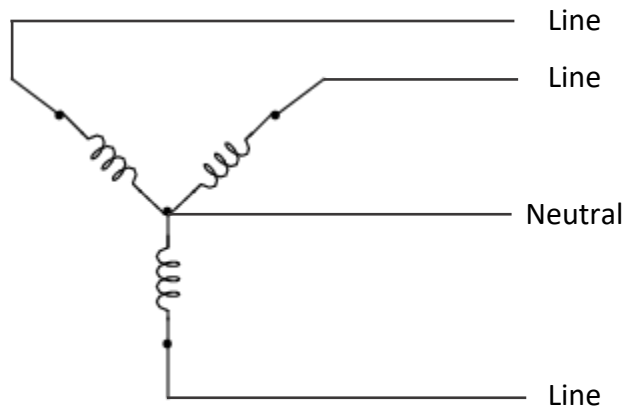
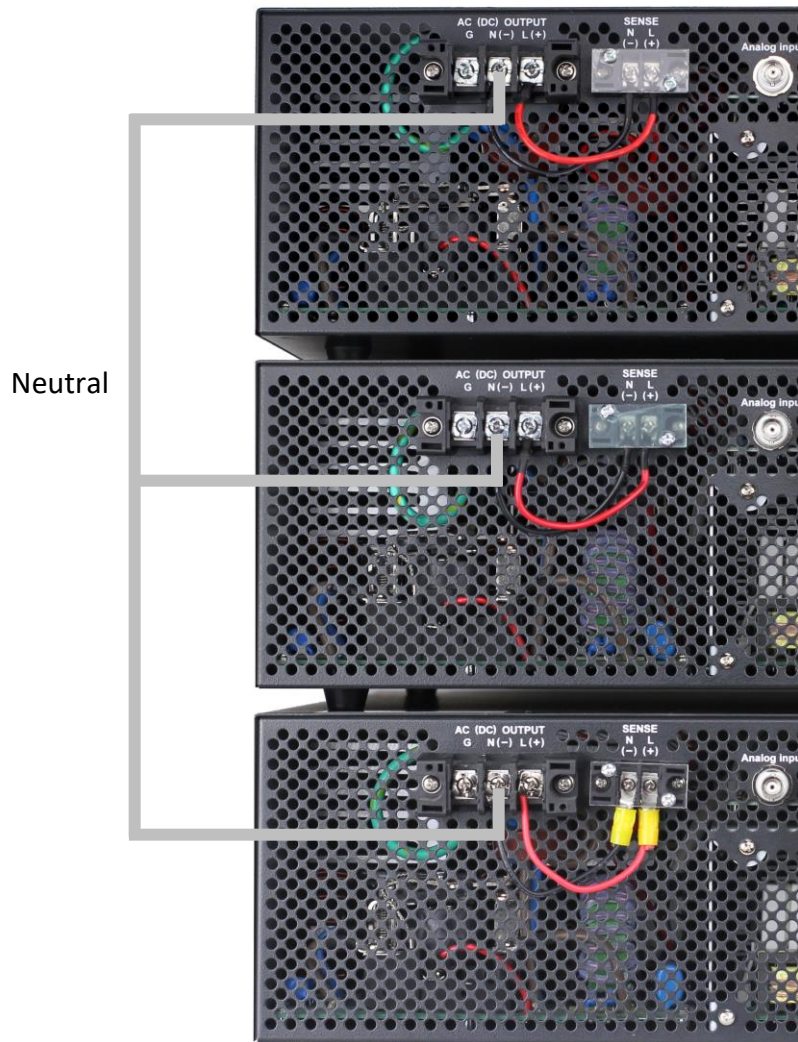

Table 11.2: TL983P pin definitions

### 11.3 3-Phase Output Wiring

The 9830B Series supports a Y-configuration in 3-phase mode.

Connect the N(-) terminals on the rear panel together as shown in Figure 11.3





## 11.4 Phase Control Software

The 9830B Series Phase control software can be downloaded from [bkprecision.com](http://bkprecision.com) by visiting the 9830B product page and clicking the 'Docs & Software' tab.

Phase control software allows you to easily control 9832B/9833B models in three-phase or multi-phase modes with data logging and live output monitoring capabilities.

### 11.4.1 Operation Modes Overview

After launching the Phase Control Software you will be prompted to select 'Three-Phase Application Mode' or 'Multi-Phase Application Mode'.



The same setting and range limitations that apply to front panel operation also apply when using the software with the exception of DC offset control.

#### *Three-phase application mode*

This mode is intended strictly for 3-Phase Operation using three 9832B or 9833B models. Setting parameters: Voltage (Vrms), Frequency (Hz), and Range apply to all three connected AC Sources. These parameters must be the same for all three AC Sources. Phase (degrees) difference between each AC source is 120° and cannot be changed. Master is fixed at 0°, Slave 1 is fixed at 120°, and Slave 2 is fixed at 240°.

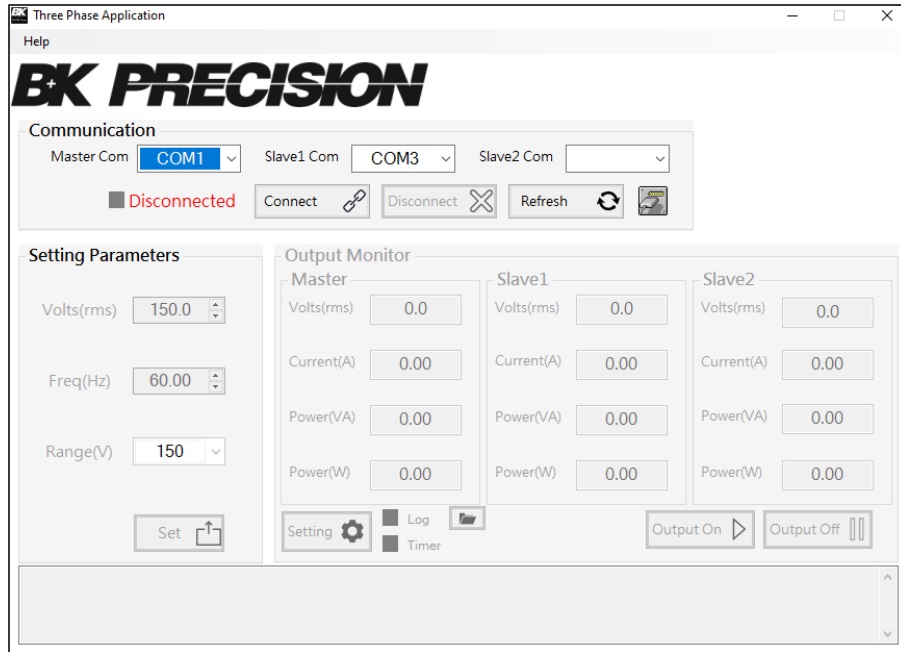

**Three-Phase Application Mode Control Panel**

*Multi-phase Application Mode*

This mode is intended for applications requiring control over more than three phases or when the user wants independent control of each AC source Voltage (Vrms) and Phase (degrees) parameters. Up to 31 instruments can be connected in multi-phase application mode.

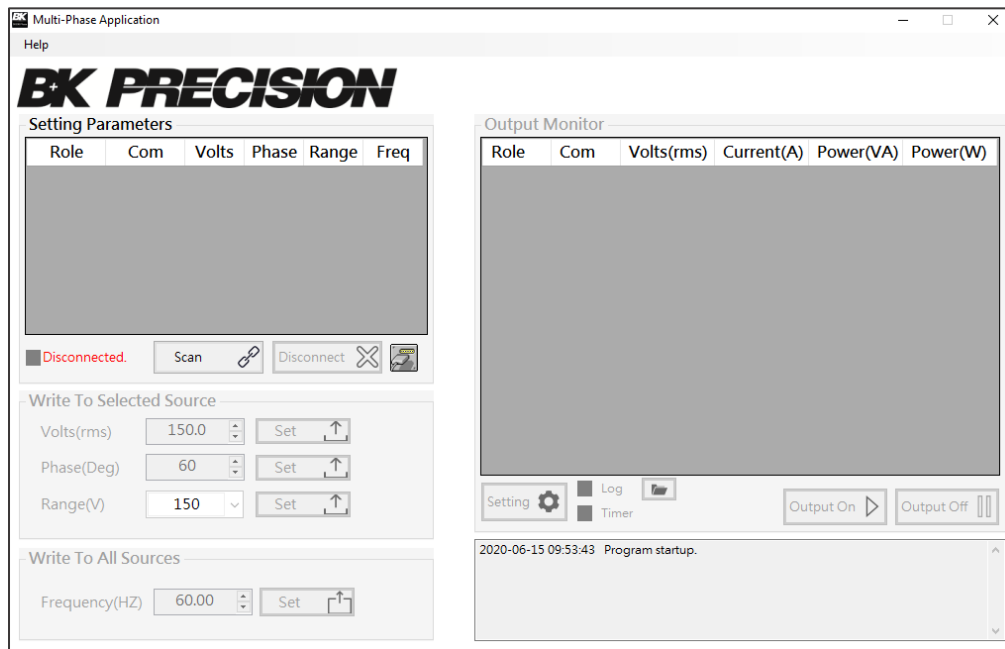

**Multi-Phase Application Mode Control Panel**

## 11.4.2 Setup and Configuration

Before attempting to connect to a computer, the 9832B/9833B AC Power Sources must be properly configured from the front panel and connected using phase sync adapter modules. See the [3-Phase Operation](#) section above for instructions.

On the front panel, set each AC source to 'USBVCP' in the communication settings.

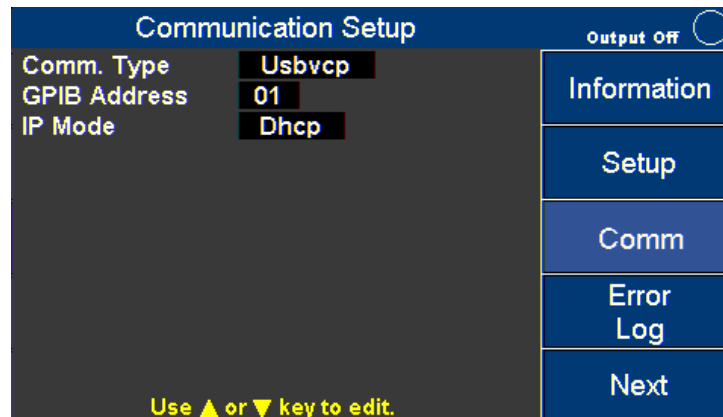

Figure 40 - Communication Setup

Press the arrow keys (**▲** **▼**) to move the cursor to the wanted configuration. Press the **ENTER** key to change its value and then press the **ENTER** key again to confirm the changes.

## 11.4.3 Three-Phase Application Mode

After following the configuration steps you can now connect the 9832B/9833B AC Power Sources to your computer using a standard USB communication cable.

Each AC Source must be connected to your computer or USB hub independently as shown:

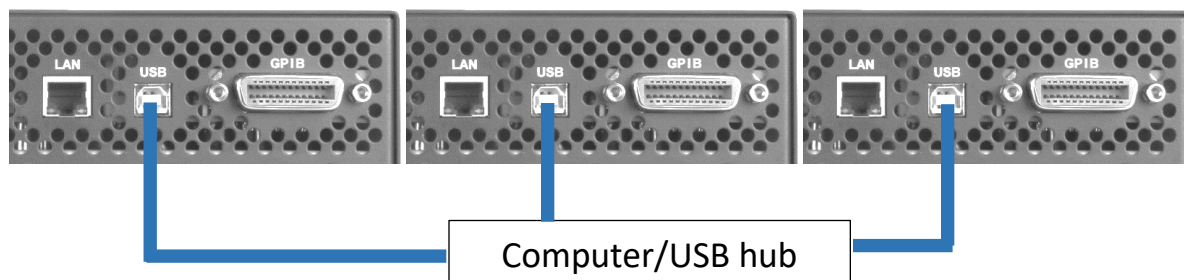

Phase control software requires a USB COMM connection, and does not support RS232 connections.

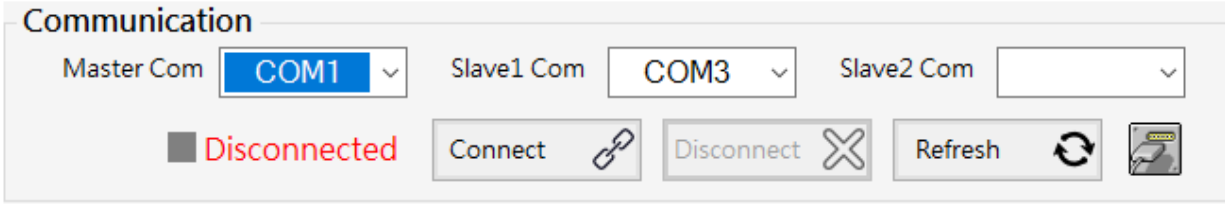

1. Open the phase control software and click the  icon to open the windows device manager. Three connected AC Sources should be displayed under 'Ports (COM & LPT)' in the device manager as shown:

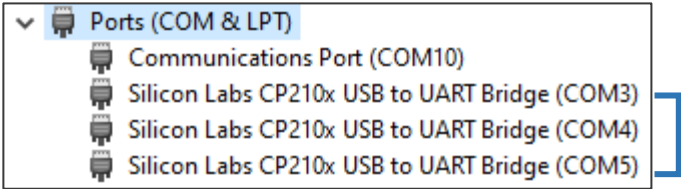

If they are missing or shown with an error power off and disconnect the AC Sources from the computer. Power back on and connect AC Sources to the computer **one at a time**.

2. Click 'Refresh' and the software will automatically search for connected AC sources and assign one master and two slaves. Alternatively, you can use the dropdown to manually assign master and slave AC sources.
3. Click 'Connect' to complete the setup process. A successful connection is indicated by the green light as shown:



*Setting Parameters*

Set Voltage (Vrms), Frequency (Hz), and Range (either 150 Vrms or 300 Vrms) for the whole 3-Phase system.

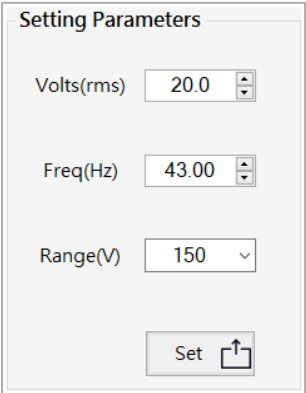

Click 'Set' to send the parameters and prepare the 3-Phase system for output.

### Output

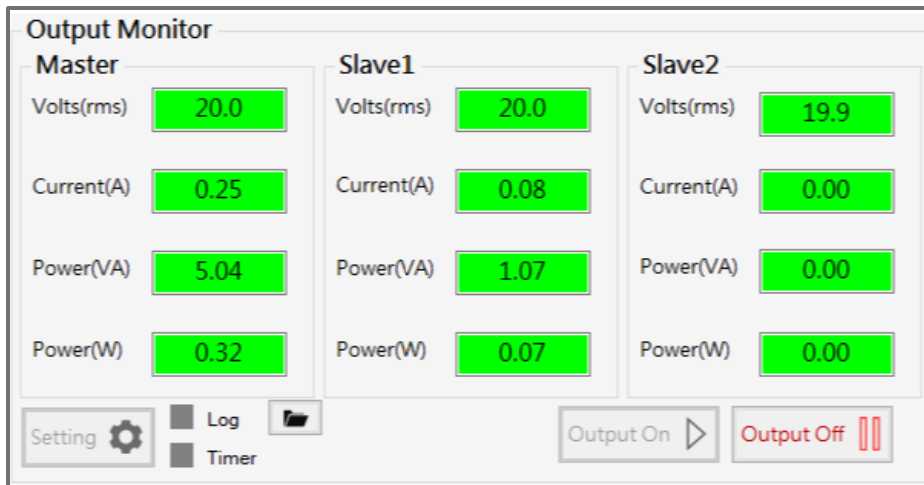

Click 'Output On' to enable the output of the 3-Phase system. Fields will be highlighted in green when the output is enabled.

The Output Monitor panel displays live Voltage (Vrms), Current (Arms), Power (VA), and Power (W).

Click 'Output Off' to disable the output of the system.

### Data Logging

This software is capable of logging time, voltage (Vrms), current (Arms), power (VA), and power (W) at user-defined sampling intervals for each AC Source. Data is exported as a .CSV file.

To enable data logging, click 'Setting' located in the Output Monitoring panel and the following menu will appear:

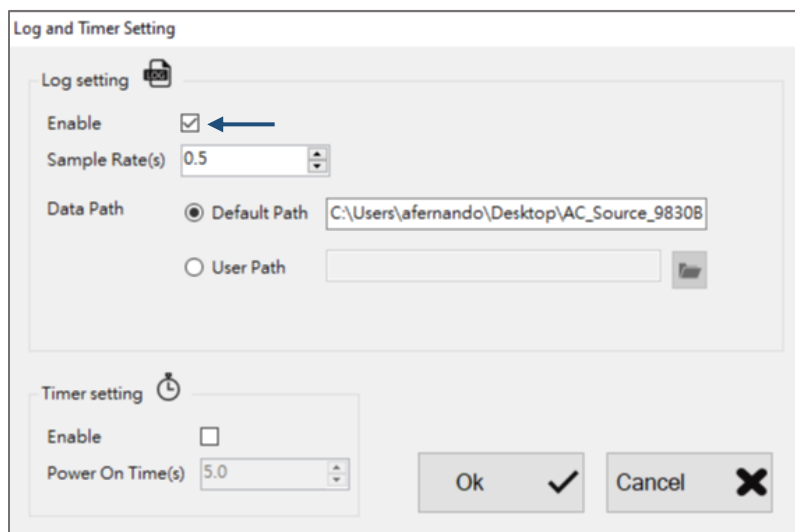

Check the box to enable data logging and set the desired sampling interval. The sampling interval is displayed in seconds (s). Data logging will start when the output is enabled.

### Output Timer

The output timer is used to disable the output after a certain period of time. The timer can be set from 1 second to over 277 hours.

To enable output timer, click 'Setting' and the following menu will appear:

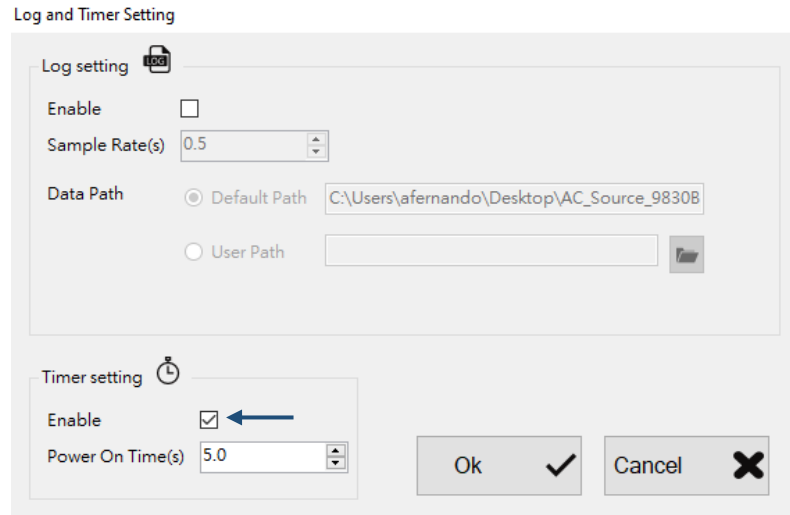

Check the box under 'Timer setting' to enable the timer. Set the desired time in seconds (s) and click 'OK' to confirm. The timer will start when the output is enabled.

## 11.4.4 Multi-Phase Application Mode

### Communication Setup

After following the configuration steps in Section 3 above you can now connect the 9832B/9833B AC Power Sources to your computer using a standard USB communication cable.

Each AC Source must be connected to your computer or USB hub independently as shown:

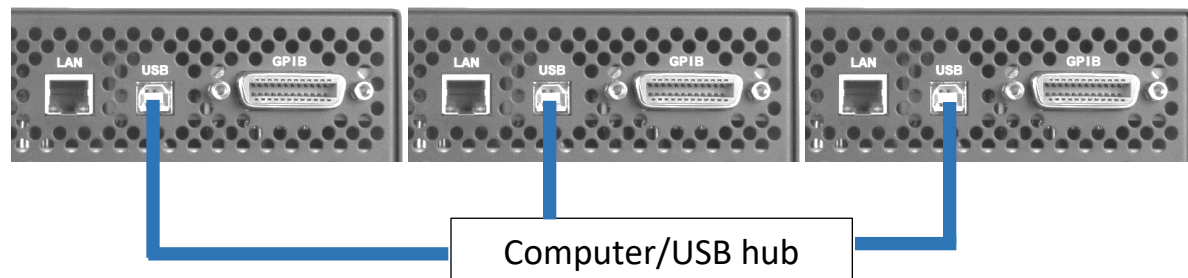

Phase control software requires a USB COMM connection, and does not support RS232 connections.

1. Click the  icon to open the windows device manager. Three connected AC Sources should be displayed under 'Ports (COM & LPT)' as shown:

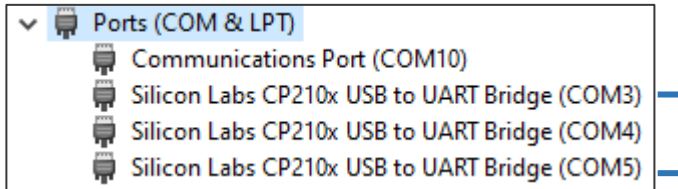

If they are missing or shown with an error power off and disconnect the AC Sources from the computer. Power back on and connect AC Sources to the computer **one at a time**.

2. Click 'Scan' and the software will automatically connect to and assign AC sources for multi-phase operation. There will be one master with the remaining connected AC sources set to slave.

### Setting Parameters

Set Voltage (Vrms), Phase (degrees), and Range (either 150 Vrms or 300 Vrms) for each AC source or the whole multi-phase system. The phase value of the master must remain at 0°. Frequency (Hz) can only be set for the whole multi-phase system.

Set parameters for each AC source individually by selecting a connected AC source listed under the 'Setting Parameters' table. The AC source you are currently setting will be highlighted in blue as shown:

Role	Com	Volts	Phase	Range	Freq
Master	COM3	20.0	0	150	60.00
Slave	COM4	20.0	200	150	60.00
Slave	COM5	20.0	240	150	60.00

Connected. Scan Disconnect

Write To Selected Source

Volts(rms) 20.0 Set

Phase(Deg) 200 Set

Range(V) 150 Set

Set parameters for the selected AC Source

Click 'Set' to send the parameters to the selected AC source(s). More than one AC source can be selected and set at a time by holding the Control (Ctrl) key on your keyboard and selecting AC sources from the list.

### Output

Click 'Output On' to enable the output of the multi-phase system. Fields will be highlighted in green when the output is enabled.

The Output Monitor panel displays live Voltage (Vrms), Current (Arms), Power (VA), and Power (W).

Role	Com	Volts(rms)	Current(A)	Power(VA)	Power(W)
Master	COM3	20.0	0.25	5.04	0.32
Slave	COM4	20.0	0.08	1.07	0.07
Slave	COM5	19.9	0.00	0.00	0.00

Click 'Output Off' to disable the output of the system.

### Data Logging

This software is capable of logging time, voltage (Vrms), current (Arms), power (VA), and power (W) at user-defined sampling intervals for each AC Source. Data is exported as a .CSV file.

To enable data logging, click 'Setting' located in the Output Monitoring panel and the following menu will appear:

Log and Timer Setting

Log setting

Enable

Sample Rate(s) 0.5

Data Path

Default Path C:\Users\afernando\Desktop\AC\_Source\_98308

User Path

Timer setting

Enable

Power On Time(s) 5.0

Ok Cancel



Check the box to enable data logging and set the desired sampling interval. The sampling interval is displayed in seconds (s). Data logging will start when the output is enabled.

### *Output Timer*

The output timer is used to disable the output after a certain period of time. The timer can be set from 1 second to over 277 hours.

To enable output timer, click 'Setting' and the following menu will appear:

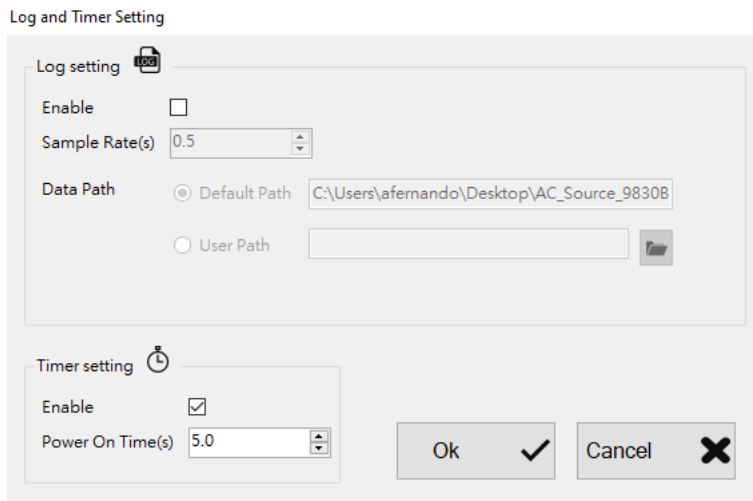

Check the box under 'Timer setting' to enable the timer. Set the desired time in seconds (s) and click 'OK' to confirm. The timer will start when the output is enabled.

## 12 Remote Interface Operation

The Instrument comes with RS232, USB (USBTMC, and USBVCP), GPIB, LAN and analog interfaces. Users can program the Instrument using the SCPI (Standard Commands for Programmable Instruments) commands through any of the remote interfaces. Only one interface at a time can be enabled and used to control the Instrument.

### 12.1 Interface Connection

#### 12.1.1 RS232

The RS232 interface can be found on pin 23 (RX) and 11 (TX) of the DB25 port. See the settings below:

Settings	Value
Baud	19200
Data bits	8
Parity	None
Stop bits	1
Flow control	None

Table 17 - RS232 Settings

Note: RS232 communication is not available in 3-phase mode

#### 12.1.2 USBVCP (virtual COM)

The USB port is a virtual COM port, which can be used for remote communication. See the settings below:

Settings	Value
Baud	19200
Data bits	8
Parity	None
Stop bits	1
Flow control	None

#### USBVCP Driver

The USBVCP driver for the SiLabs CP210x used in the unit can be downloaded from the following link.

[https://bkpmedia.s3.amazonaws.com/downloads/software/CP210X\\_USB\\_Driver.zip](https://bkpmedia.s3.amazonaws.com/downloads/software/CP210X_USB_Driver.zip)

#### **NOTICE**

The USB interface does not support flow control. The programmer should be aware of this limitation and pay attention to the Instrument command process time. If the remote commands are sent too fast the internal buffer may overrun and cause communication errors. Therefore, it is mandatory to add a delay between commands so that the Instrument can have sufficient time to process.

### 12.1.3 *USBTMC*

The USB port is USBTMC-compliant and can be used for remote communication and control. There are no additional settings in the menu system for USB configuration. The only requirement is that the USBTMC driver be installed. It is included when installing VISA software on the computer. (We recommend using NI-VISA, which can be downloaded at <http://www.ni.com/visa/>).

### 12.1.4 *GPIB*

Each device is assigned a GPIB address from 1-30. To communicate via GPIB, connect a GPIB cable to the GPIB interface on the back of the instrument and configure the address.

### 12.1.5 *LAN (Ethernet)*

There are three ways to control the Instrument via LAN interface: Web server, Telnet connection, and Socket connection.

### 12.1.6 *Web server*

There is an embedded web server GUI (Graphical User Interface) that can access the Instrument via LAN interface using a web browser. Using a web browser from a computer connected to the same local area network as the Instrument. The GUI provides a simple way to set the voltage and current, and to monitor the output. To use this function, follow the steps below:

Open up a web browser on the computer.

1. Check the IP address of the Instrument through menu tree System → Information.
2. Enter the IP address of the Instrument in the URL bar of your browser with IP Address
  - a. For example 192.100.111.

If correctly configured, the following screen will be shown:

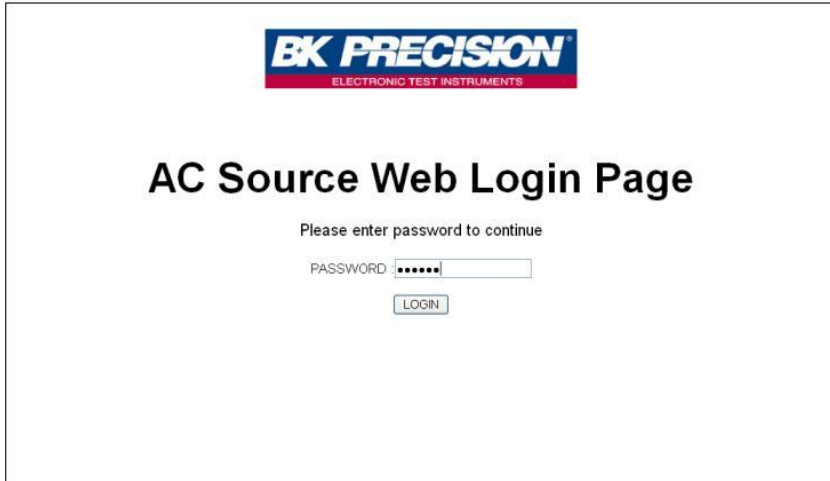

Figure 41 - Web Login Page

A password is required to login and access the menu items on the page.

The default admin password is **123456**.

The web server menu items are described below:

## HOME

This page provides general information about the instrument, Manufacturer, Model Number, Serial Number, Firmware version, Interface, USBTMC setting, MAC address, and IP Address.

AC Source Web Control	
<b>Home</b>	
Manufacturer	B&K PRECISION
Model	9833B
Serial Number	XXXXXX
Firmware version (UI/MB/PFC/INTERFACE)	6.21/7.10/7.20/1.H0/9.00ZB
Interface	LAN
USB (USBTMC/488)	USB0:0xFFFF:0x7749::XXXXXX::INSTR
MAC address	00:17:F8:FF:FF:66
IPv4 Address	192.168.100.111

Copyright (c) BK Precision V1.00

Figure 42 - Home Page

## LAN Config

This page provides settings and status of LAN, including IP address, IP subnet, Gateway, DNS server, Hostname, Domain, mDNS host name, TCP/IP VXI-11 instrument, and TCP/IP Raw Socket.

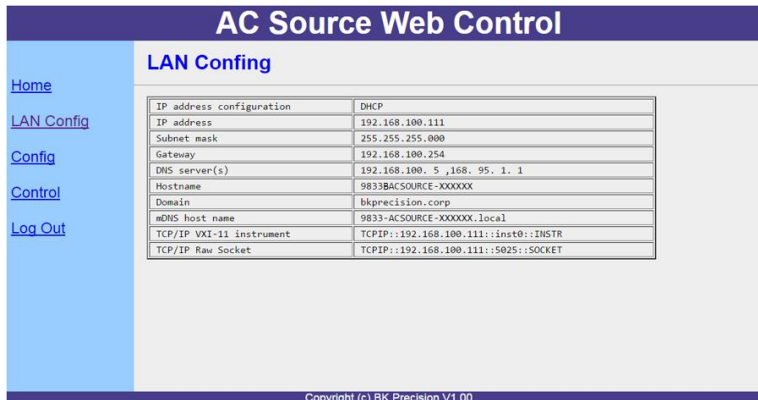

IP address configuration	DHCP
IP address	192.168.100.111
Subnet mask	255.255.255.000
Gateway	192.168.100.254
DNS server(s)	192.168.100.5 ,168.95.1.1
Hostname	9833BACSOURCE-XXXXXX
Domain	bkprecision.corp
mDNS host name	9833-ACSOURCE-XXXXXX.local
TCP/IP VXI-11 instrument	TCPIP::192.168.100.111::inst0::INSTR
TCP/IP Raw Socket	TCPIP::192.168.100.111::5025::SOCKET

Copyright (c) BK Precision V1.00

Figure 43 - LAN Config

## Config

The Config page provides different settings output voltage range, waveform A/B, output type, inrush current. Limitations can also be set for R.M.S. voltage, +/- Peak voltage, output R.M.S. current and output power.

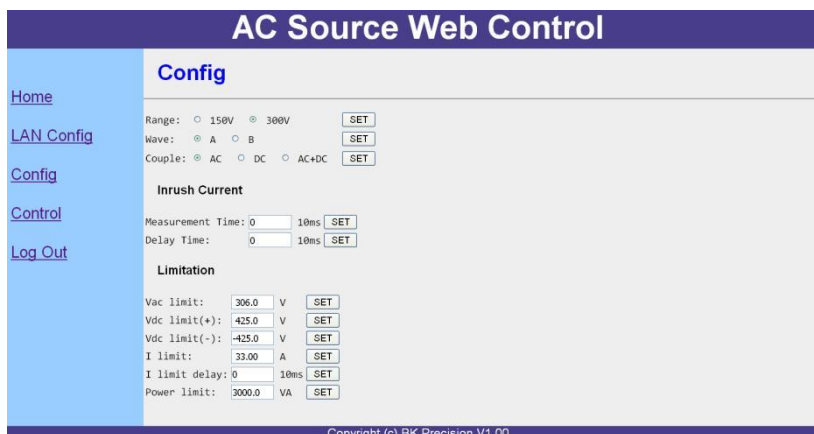

Range:  150V  300V

Wave:  A  B

Couple:  AC  DC  AC+DC

**Inrush Current**

Measurement Time: 0  10ms

Delay Time: 0  10ms

**Limitation**

Vac limit: 306.0  V

Vdc limit(+): 425.0  V

Vdc limit(-): -425.0  V

I limit: 33.00  A

I limit delay: 0  10ms

Power limit: 3000.0  VA

Copyright (c) BK Precision V1.00

Figure 44 - Source Config

## Control

The Control page provides the general control of the instrument such as output on/off as well as the AC/DC voltage and frequency settings. The command line for SCPI commands can also be accessed here.

The screenshot displays the 'AC Source Web Control' interface. On the left is a navigation menu with links for Home, LAN Config, Config, Control, and Log Out. The main content area is titled 'Control' and features a 'Measurement' section with a table of values: Vrms= 0.0V, Vdc = 0.0V, Freq= 0.0Hz, Irms= 0.00A, Pwr = 0.0W, Ip+ = 0.00A, Ip- = 0.00A, CF = 0, PF = 0, Iinr= 0.00A, S = 0.0VA, and Q = 0.0VAR. Below this are control settings for Output Relay (OFF/ON), Vac (0.1 V), Frequency (60.00 Hz), Sync source (IMMED/PHASE), Phase (0.00 degree), and ON/OFF (OFF/ON), each with a 'SET' button. An SCPI section includes a command input field and a 'SEND' button. The footer indicates 'Copyright (c) BK Precision V1.00'.

Figure 45 - Source Control

## Log Out

The Log Out will exit the web page and go back to login screen. The instrument can be connected via LAN (Ethernet) or Telnet client with a socket port of **5024** Socket connection. Socket connection is available for communication via LAN (Ethernet) interface. Users can use this port to open a raw socket connection for sending remote commands. The socket port is: **5025**

## 13 Digital I/O

The digital I/O interface is used to control or monitor the Instrument. Refer to the figure below describing the digital I/O 25-pin.

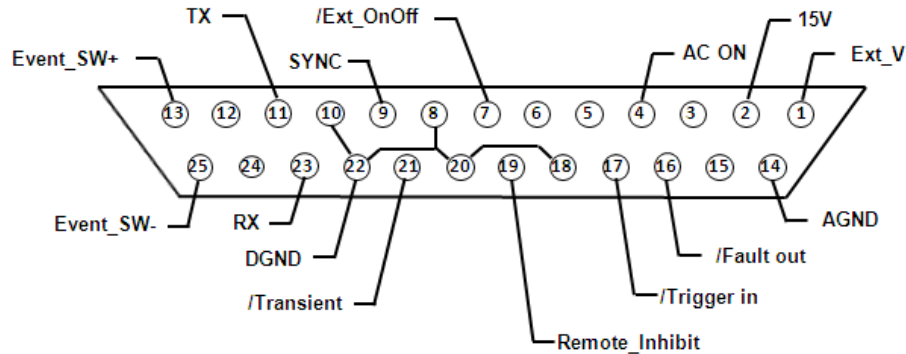

Figure 46 - Digital IO Pinout

Pin	Name	I/O	Definition	Range
1	Ext_V	IN	External reference voltage input pin. (reference ground: AGND) In DC mode, enter -10V to +10V to control the DC output. In AC mode, enter 0 to +10V to control the AC output. Not supported in AC+DC mode.	-10 V to 10 V (DC) 0 to +10 V (AC)
2	15 VDC	OUT	+15VDC output. (reference ground: AGND)	(15±0.8) V, 100 mA
3	NONE			
4	AC ON	OUT	When the output of the Instrument is active, the voltage level of this pin is high (5V); otherwise the voltage level is low (0V). (reference ground: DGND)	5 V, 0 V, 1 mA
5	Reserved		Reserved	
6	Reserved		Reserved	
7	/Ext_OnOff	IN	This pin is used with Trigger_in (pin17). When the voltage level of this pin is low, the Instrument will stop output. When the voltage level is high, the Instrument will start output. (Refer to the description below for more details)	5 V
8	DGND	PWR	Digital ground	
9	/SYNC	OUT	The synchronize signal	12 V , 10 mA
10	DGND	PWR	Digital ground	
11	Tx	OUT	RS232 transmitter	±9 V , 10 mA
12	NONE			

13	Event_SW+	IN	Built-in switch + (control the switch on or switch off via the SCPI commands)	
14	AGND	PWR	Analog ground	
15	NONE			
16	/Fault_out	OUT	When protection status is active, the voltage level of this pin will turn from high to low. (reference ground: DGND)	5 V, 0 V, 1 mA
17	/Trigger_in	IN	When this pin receives a falling edge, it will trigger the output of the Instrument	5 V
18	DGND	PWR	Digital ground	
19	/Remote_inhibit	IN	When the voltage level of this pin is low, the Instrument output will be off. If the voltage level is returned from low to high the output will remain off. To restart output, press Enter or OK key for 2 seconds. (Refer to the description below for more details)	5 V
20	DGND	PWR	Digital ground	
21	/Transient	OUT	When the output status of Instrument has changed, this pin will out a 500uS active low pulse. (Refer to the description below for more details)	5 V, 0 V, 1 mA
22	DGND	PWR	Digital ground	
23	Rx	IN	RS232 receiver	±9 V
24	NONE			
25	Event_SW-	IN	Built-in switch - (control the switch on or off with SCPI commands)	

Table 18 - Digital IO - Pinout

### 13.1 External Voltage Control

The external reference voltage (Ext\_V) pin controls the R.M.S. voltage of the Instrument. The reference voltage is between pin 1 and AGND pin 14.

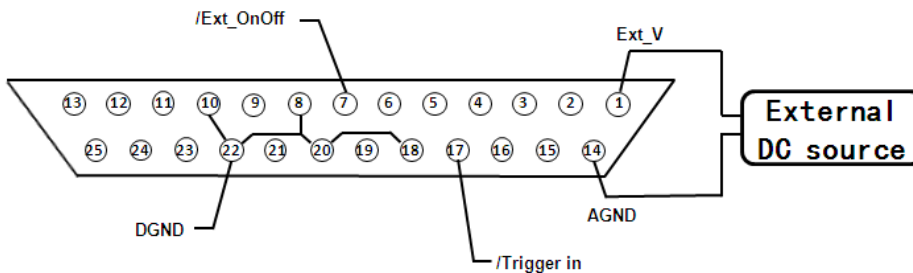

Figure 47 - External Voltage Pinout



To activate this function, configure the settings below:

Configure → Config 2 → External Ref. → Level

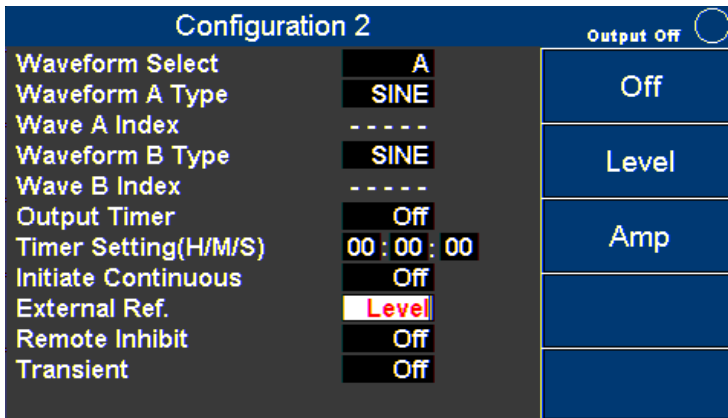

Figure 48 - External Reference Voltage Function

### 13.1.1 AC Couple

AC couple is selected by setting: Configure → Config 1 → Couple → AC. The reference voltage is proportional to the Instrument voltage.

1 Vdc reference voltage = 30 Vac Instrument

---

**NOTE: Input voltage cannot exceed 0 to 10 V in AC couple mode.**

---

### 13.1.2 DC Couple

DC couple is selected by setting: Configure → Config 1 → Couple → DC. The reference voltage is proportional to the source voltage.

±1 Vdc reference voltage = ±42 Vac source

---

**NOTE: Input voltage cannot exceed -10 V to +10 V in DC couple mode.**

---

This function is not supported when Configure → Config 1 → Couple → AC+DC.

## 13.2 Trigger In

To activate the Trigger function, follow the settings: Configure → Config 2 → External Ref. → Level.

This instrument has a trigger input on pin 17 of the digital IO interface. Trigger\_in is high at 5 V and low at 0 V. The Instrument will respond to the falling edge of Trigger\_in and

Ext\_OnOff (external output control) according to the following control table and timing diagram.

/Trigger_in	/Ext_OnOff	Result
Falling Edge	LOW	Instrument output STOP
Falling Edge	HIGH	Instrument output ON
HIGH	LOW	No change
HIGH	HIGH	No change
Falling Edge	LOW	Instrument output STOP
HIGH	LOW	Instrument output ON

Table 19 - Control Table

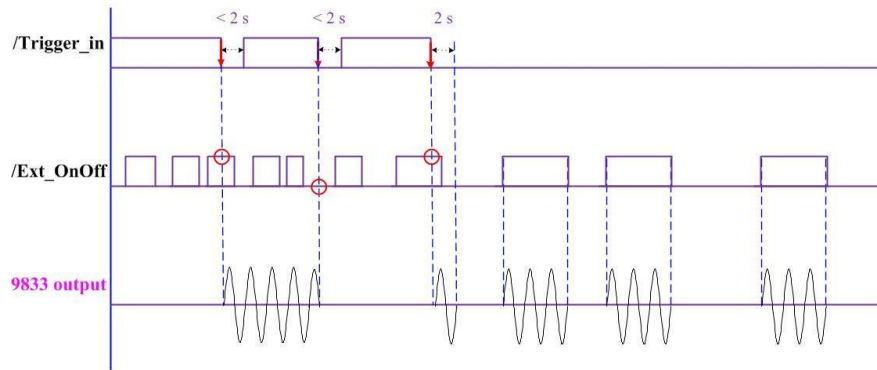

Figure 49 - Trigger Timing Diagram

### 13.3 15 VDC

This instrument supplies 15 VDC up to 100 mA between pin 2 (15VDC) and pin 14 (AGND).

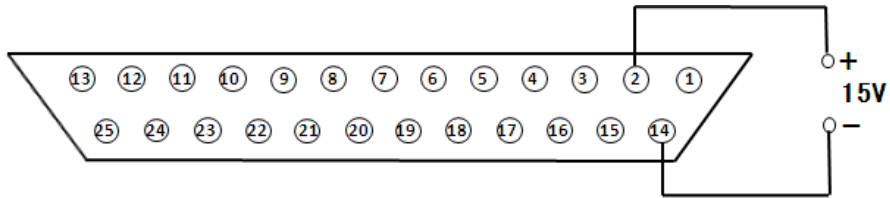

Figure 50 - 15 V supply

## 13.4 Output Status Detection

The digital IO interface has system status logic outputs that are described in this section. All these outputs are in reference to DGND, pins 8, 10, 18, 20, and 22.

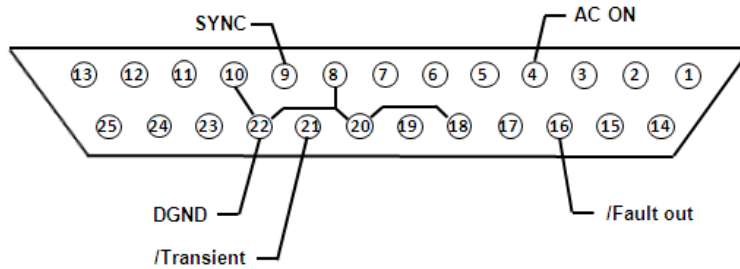

Figure 51 - Output status pin out

### 13.4.1 /SYNC

When the output sine wave of the Instrument is about to pass through 0 degrees, pin 9 (/SYNC) will send out a 250 uS 12 V to 0 V pulse as shown in the below timing diagram. This output

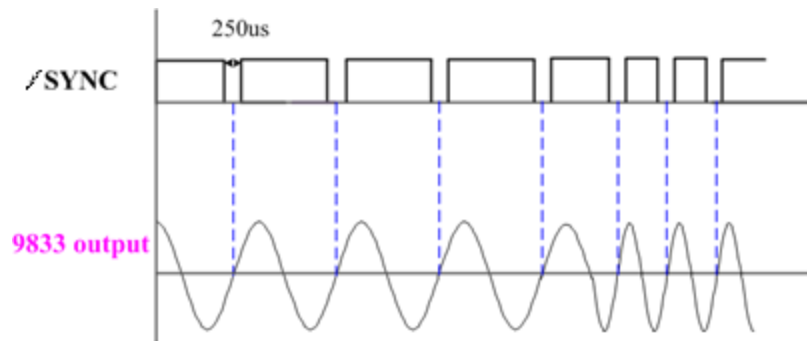

Figure 52 - Sync Timing Diagram

### 13.4.2 */Fault\_out*

Pin 16 (*/Fault\_out*) indicates when a fault occurs or the Instrument is in protection status. During normal operation, the voltage level of this pin stays high (5 V).

The voltage level will be low (0 V) if any of the circumstances below occurs:

4. Interface CAN Error
5. Module CAN Error
6. SW Over Current Prot
7. SW Over Voltage Prot
8. SW Over Power Limit
9. SW Over Max VA Limit
10. Remote Inhibit ON

### 13.4.3 */Transient*

When the output status changes, pin 21 (*/Transient*) will send out a 500  $\mu$ s, 5 V to 0 V pulse to synchronize with another external device as shown in the below timing diagram. This function is not available in the Program modes.

To active this function, follow the settings: Configure  $\rightarrow$  Config 2  $\rightarrow$  Transient  $\rightarrow$  ON.

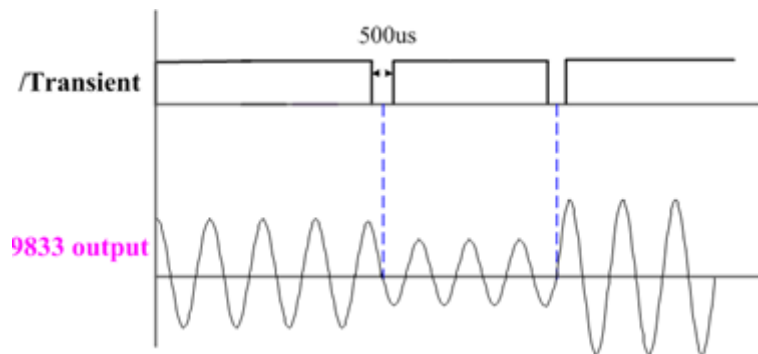

Figure 53 - Transient Timing Diagram

## 13.5 Remote\_Inhibit

The Instrument offers a remote inhibit used to turn the output off. The voltage level of pin 19 (Remote\_inhibit) (reference ground is DGND) has to be set high (5 V) first, or the Instrument will enter into protection mode. If the voltage level drops to 0 V, the Instrument will stop outputting, and will show 'Error Remote Inhibit ON'.

Follow the settings: Configure → Config 2 → Remote\_Inhibit → ON

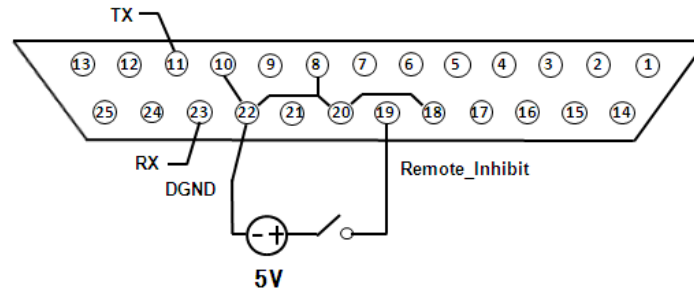

Figure 54 - Remote Inhibit Connection

To restore the output back to On, first set the voltage level to high (5V), then press and hold the **ENTER** key for 2 seconds.

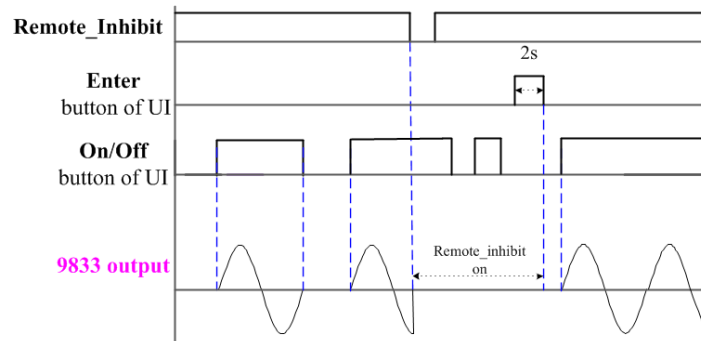

Figure 55 - Remote Inhibit Timing Diagram

## 13.6 Tx / Rx

Pin 11 (Tx) and pin 23 (Rx) (reference ground is DGND) are the send and receive lines of the RS232 interface. Open System → Comm → Select RS232 and activate the transmission function in Comm.

Settings	Value
Baud	19200
Data bits	8
Parity	None
Stop bits	0
Flow control	None

Table 20 - RS232 Settings

**NOTICE**

The RS232 interface does not support flow control. The programmer should be aware of this limitation and pay attention to the Instrument command process time. If the remote commands are sent too fast the internal buffer may overrun and cause communication errors. Therefore, it is mandatory to add a delay between commands so that the Instrument has sufficient time to process.

## 13.7 Event\_SW

The Event\_SW output can be used to control external devices. The Instrument uses a opto-coupler with an NPN transistor output.

Event switch ratings	
Voltage	- 6 to 60 V maximum
Current	50 mA maximum

Table 21 - Event Switch Power

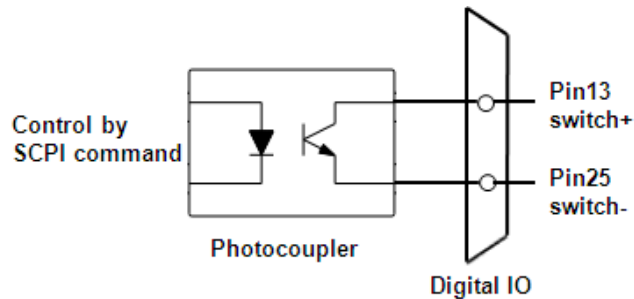

Figure 56 - Event Switch Diagram

To activate this function, connect to pin 13 (Event\_SW+) and pin 25 (Event\_SW-), and then give switch on/off command through SCPI command.

Command	Description
TEST:DIGI ON	To activate the switch on/off function
TEST:DIGI:IO:SWITCH ON	Switch on
TEST:DIGI:IO:SWITCH OFF	Switch off
TEST:DIGI OFF	To disable the switch on/off function

Table 22 - Event Switch Commands

**Note:** DIGI must be set ON to make changes to the switch on/off state.

## 13.8 Analog input (BNC)

The analog input(BNC) is used to control the output voltage of the instrument with an external signal. In this example, an Arbitrary waveform generator is connected.

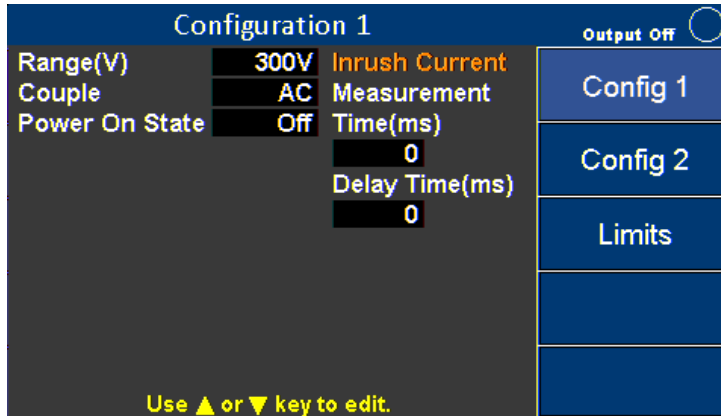

Figure 57 Configuration 1 page

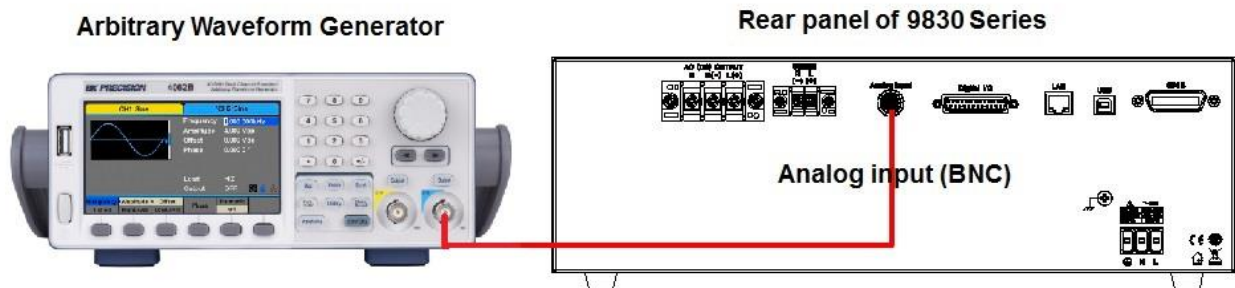

Figure 58 – Analog Input Connection

Press **Configure** softkey in the Setting and Measurement screen. Configure as follows :  
Config 1(default) → Config 2 → Limits

Press **Config 2** softkey to enter the Configuration 2 setting page. Use the arrow key (▲  
▼) to move the cursor to the External Ref., then press the **ENTER** key to change value.  
Select the **Amp** softkey and press **ENTER** to save the setting.

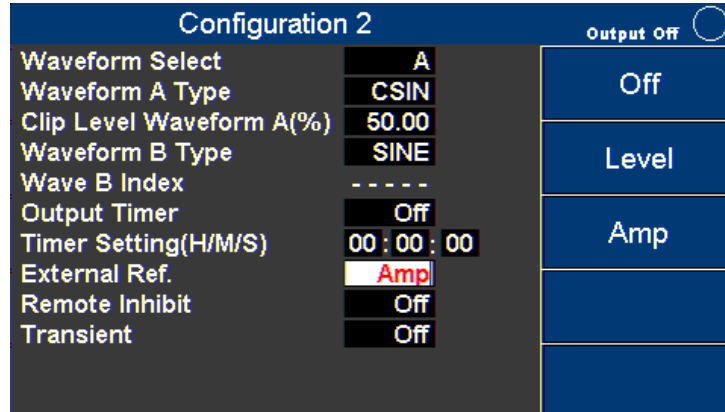

Figure 59 - Configuration 2 Amp mode

Press **ESC** to go back to the Setting and Measurement screen. Set the arbitrary waveform generator, to output 6Vrms / 60Hz sine wave, then press **On/Off** key to start the output. If the AC output voltage range is 150V, the output voltage will be 150Vrms.



# 14 Built-in Harmonic Wave

THD 00

Harmonic	2	5	7	8
weight(%)	2.07	9.8	15.8	2.16

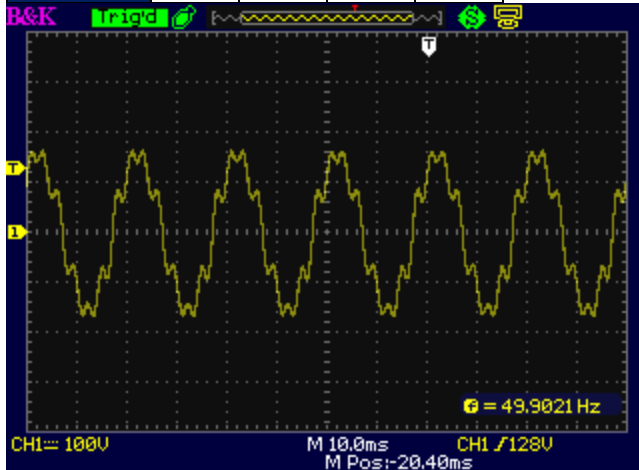

THD 01

Harmonic	3	7	19
weight(%)	1.5	1.5	2

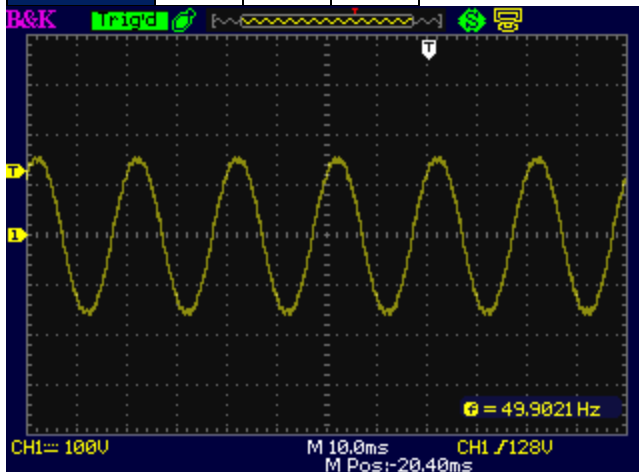

THD 02

Harmonic	3	5	7	23	31
weight(%)	2	14	2	1.4	1

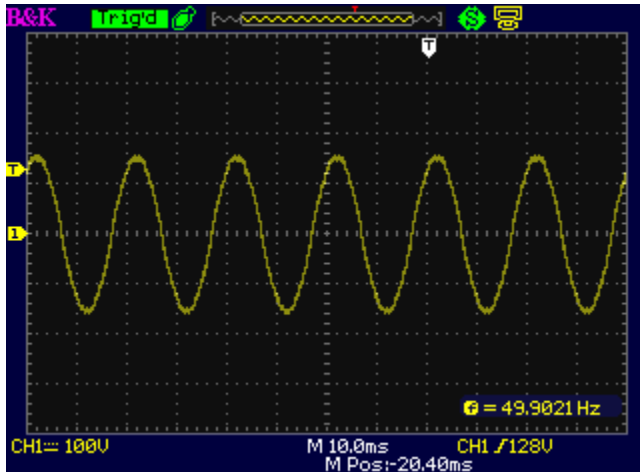

### THD 03

Harmonic	3	5	7	23	25	31	33
weight(%)	2.5	1.9	2.5	1.9	1.1	1.5	1.1

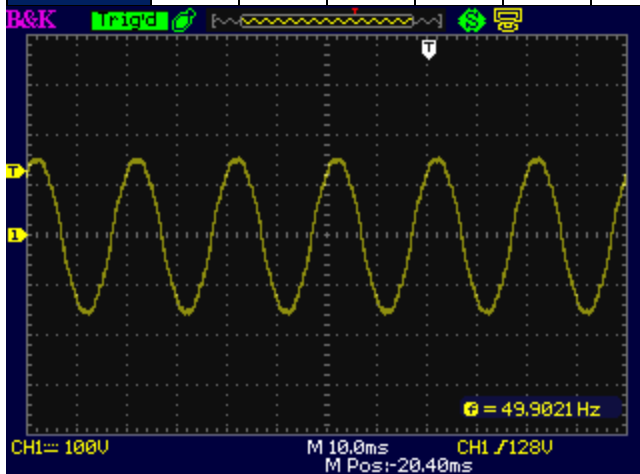

### THD 04

Harmonic	3	5	7	9	11
weight(%)	1.1	2.8	1.4	2.3	1.5

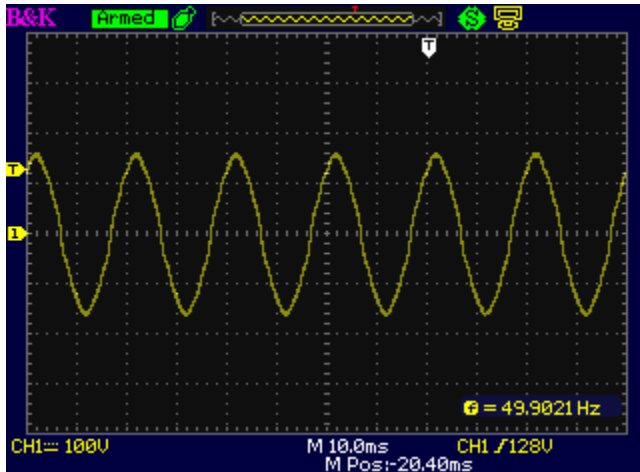

### THD 05

Harmonic	3	5	7	15	19
weight(%)	1.65	4.2	3.45	1.05	3

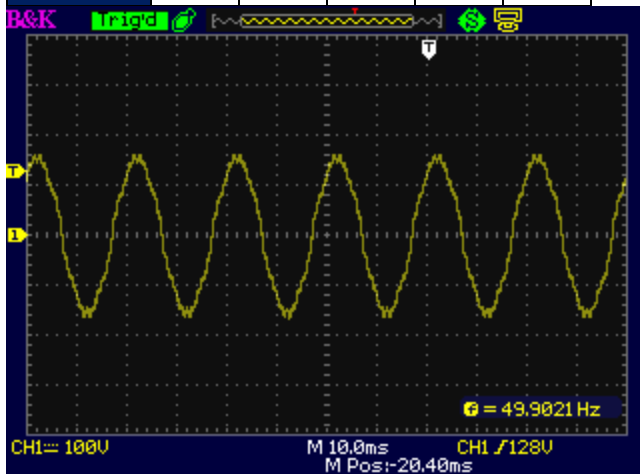

### THD 06

Harmonic	3	5	7	9	11	15	21
weight(%)	2.2	5.6	2.8	4.6	3	1.4	1

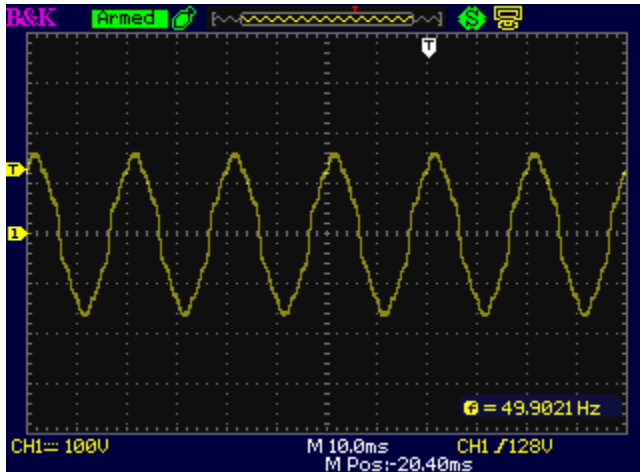

### THD 07

Harmonic	3	5	7	11	15	17
weight(%)	4.9	1.6	2.7	1.4	2	1.1

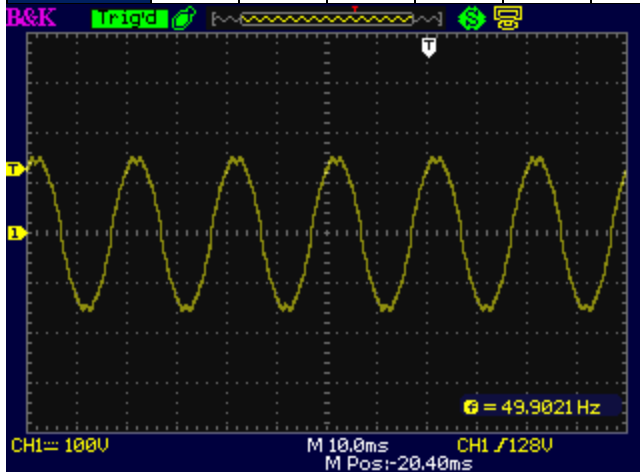

### THD 08

Harmonic	3	5	7	11	13	15	17	19	21	23	25
weight(%)	7.35	2.4	4.05	2.1	1.05	3	1.65	1.05	1.05	1.2	1.05

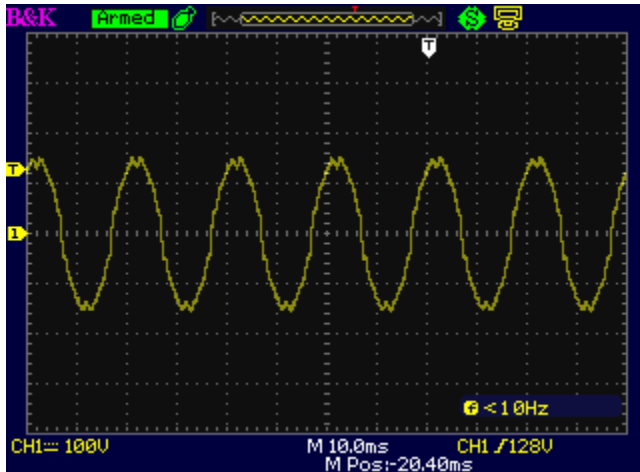

### THD 09

Harmonic	3	5	7	9	11	13	15	17	19	21	23	25
weight(%)	9.8	3.2	5.4	1.2	2.8	1.4	4	2.2	1.4	1.4	1.6	1.4

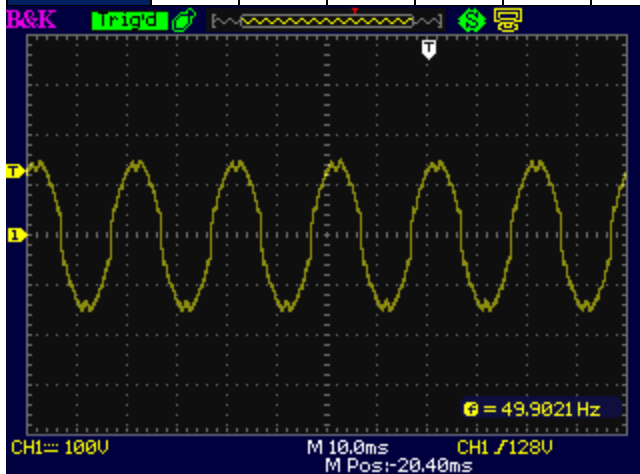

### THD 10

Harmonic	3
weight(%)	17.8

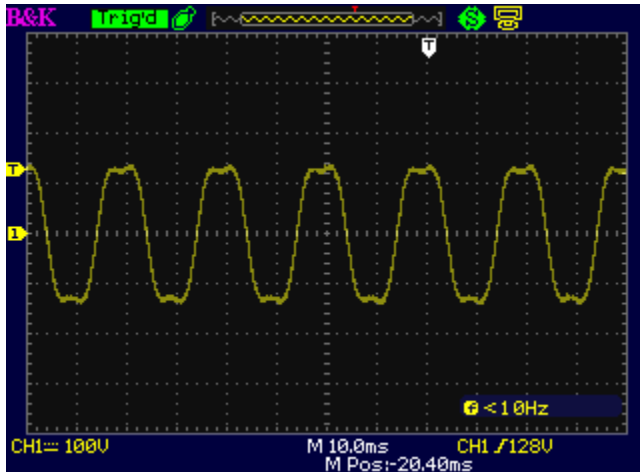

### THD 11

Harmonic	3
weight(%)	21.3

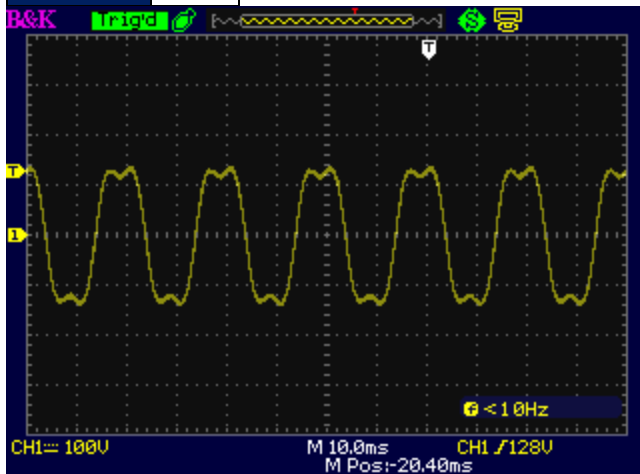

### THD 12

Harmonic	3
weight(%)	24.5

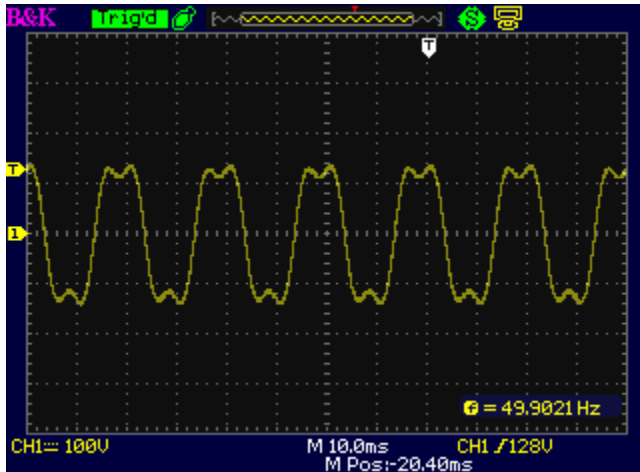

### THD 13

Harmonic	2	5	7	8
weight(%)	2.3	9.8	15.8	2.5

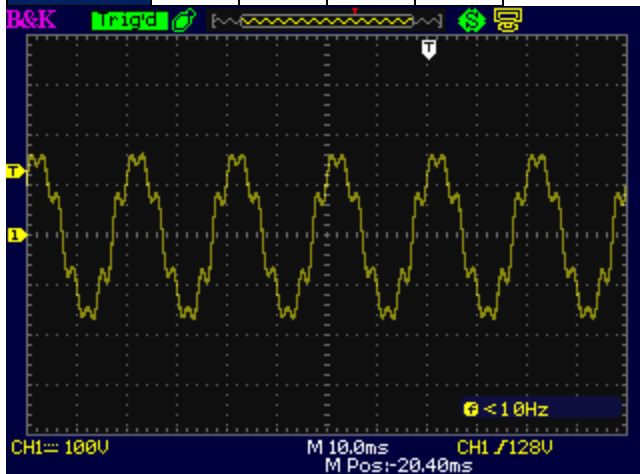

### THD 14

Harmonic	2	5	7	8
weight(%)	1.15	4.9	7.9	1.25

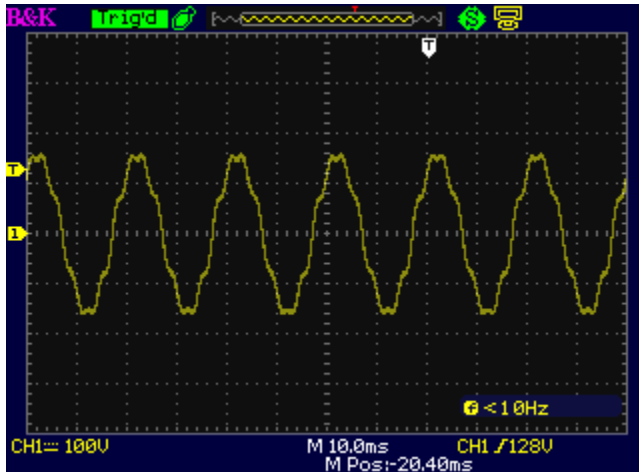

### THD 15

Harmonic	5	7
weight(%)	2.45	3.95

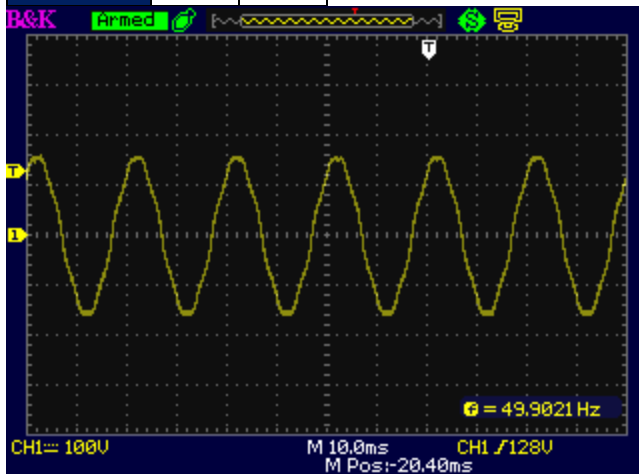

### THD 16

Harmonic	3	5	7	9
weight(%)	11	4.05	2	1.3



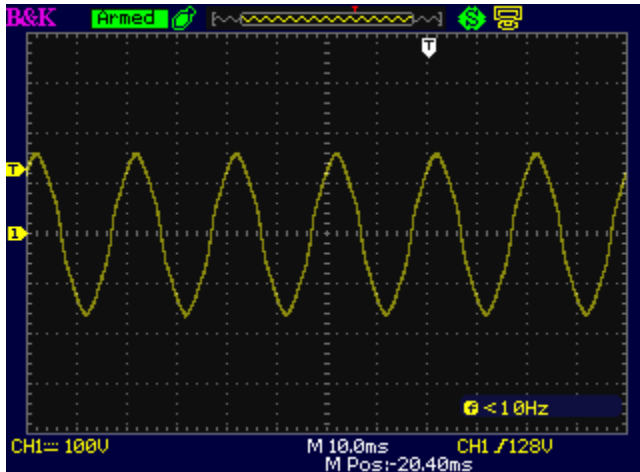

### THD 17

Harmonic	3	5	9
weight(%)	7.17	3.42	0.8

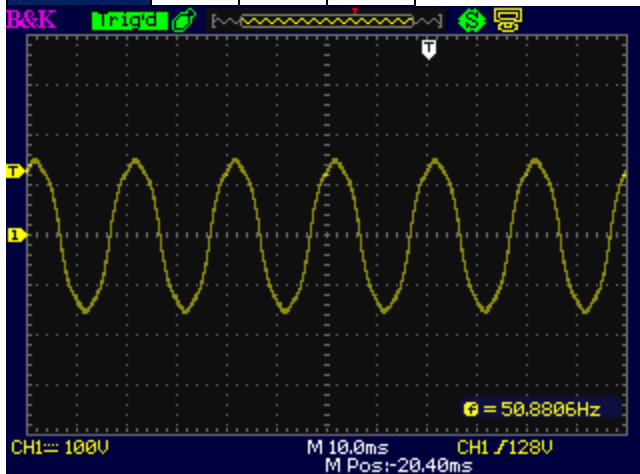

### THD 18

Harmonic	3	5	9
weight(%)	8.11	3.48	1

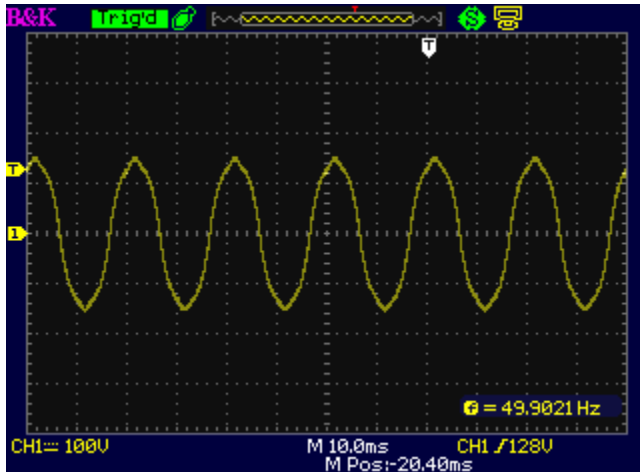

### THD 19

Harmonic	3	5	9
weight(%)	9.38	3.44	1.15

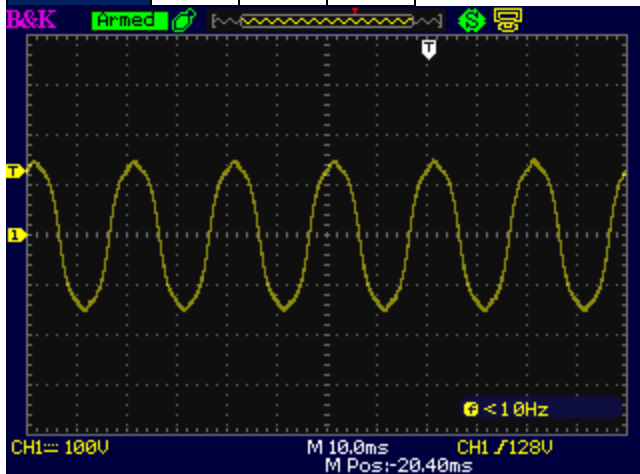

### THD 20

Harmonic	3	5	7	9	11
weight(%)	2	1.8	1.6	1.23	0.9

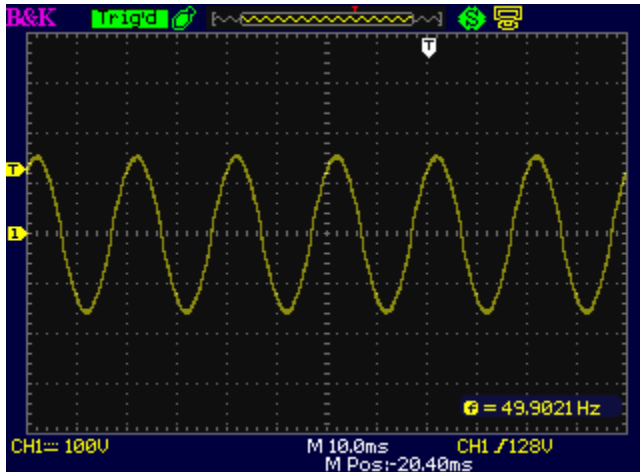

### THD 21

Harmonic	3	5	7	9	11	13
weight(%)	3	2.75	2.4	2	1.4	0.8

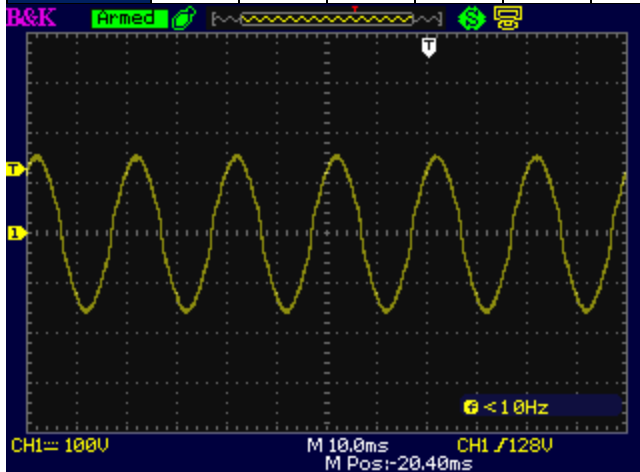

### THD 22

Harmonic	3	5	7	9	11	13
weight(%)	4.15	3.8	3.24	2.6	2	1.25

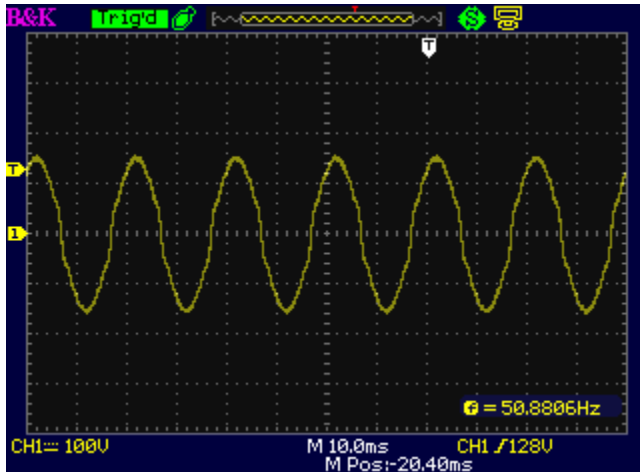

### THD 23

Harmonic	3	5	7	9	11	13	15	21	23	25	27	29
weight(%)	5.63	5.13	4.42	3.56	2.63	1.68	0.79	1.04	1.27	1.32	1.2	0.95

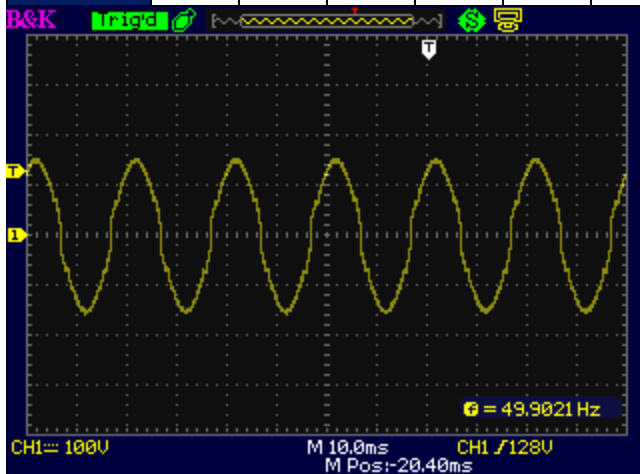

### THD 24

Harmonic	3	5	7	9	11	13	15	21	23	25	27	29
weight(%)	7.28	6.63	5.71	4.61	3.42	2.19	1.04	1.32	1.63	1.69	1.54	1.22

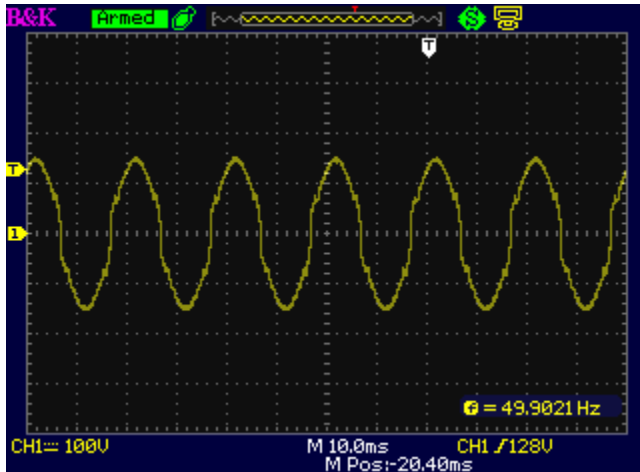

**THD 25**

Harmonic	5	7	11	13	19	23	25	35	37
weight(%)	3.54	2.68	8.87	7.86	1.04	4.11	4.13	2.61	2.82

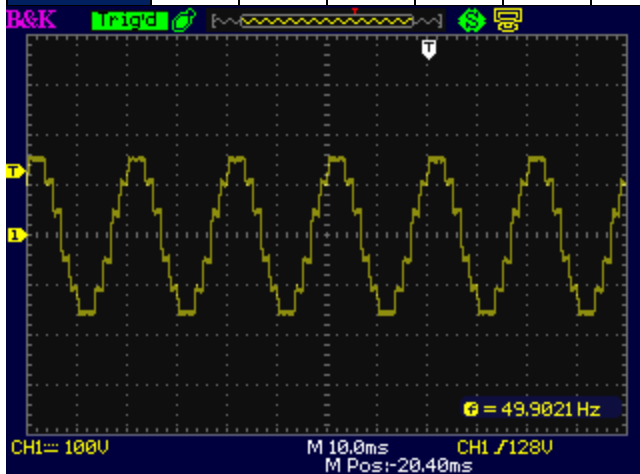

**THD 26**

Harmonic	21	23	25
weight(%)	1.38	5.39	2.29

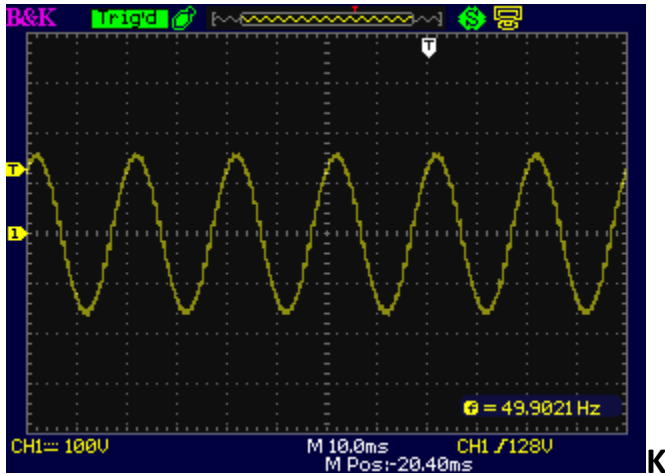

K

### THD 27

Harmonic	3	5	7	9	11	13	15	17	19	21	23	25	27	29	31	33	35	37	39
weight(%)	33	20	14	11	8.5	7.2	6	5	5	4.5	4	3.5	3	2.5	2	2	2	2	2

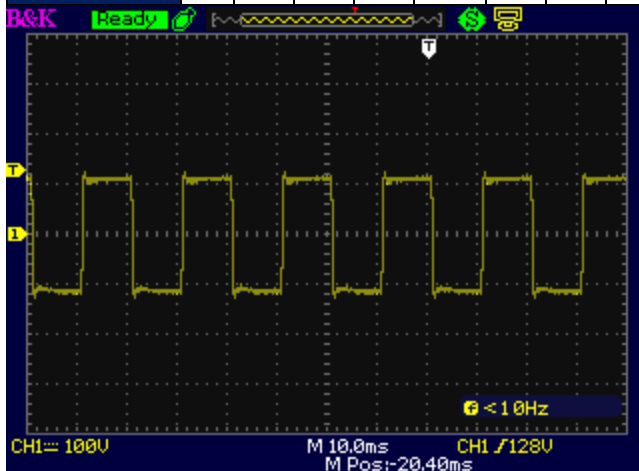

### THD 28

Harmonic	3	5	7	9	11	13	15	17	19	21	23	25	27	29	31	33	35	37	39
weight(%)	33	20	14	11	8.5	7.2	6	5	5	4.5	4	1	1	1	1	1	1	1	1

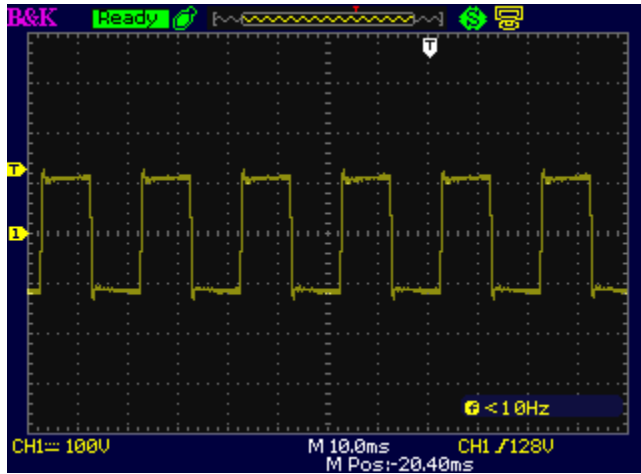

### THD 29

Harmonic	3	5	7	9	11	13	15
weight(%)	33.3	20	13.8	10.8	8.5	7.2	5.5

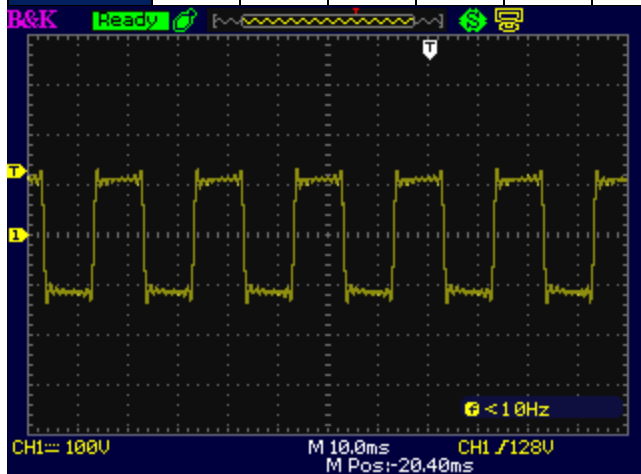

## 15 Calibration

B+K Precision recommends a calibration interval of one year for this instrument. To perform the calibration, the following equipment is required:

5 1/2 digital multimeter (DMM); B+K Precision 5492B or equivalent

DC source: BK Precision 9110 or equivalent

Resistive load: 3 ohm with rated power over 5,600 watts

### **WARNING**

Calibration must only be performed by authorized technicians or calibration personnel only. If you are not authorized, do not attempt to calibrate the instrument yourself, as you may damage the instrument and void the warranty.

To enter the calibration procedure, access the menu tree System → Next → Calibration.

Enter the password **13579** by number keys followed  key to confirm.

The calibration items are as below:

VMEAS

IMEAS

VDC

External\_Calibration

### 15.1 AC Voltage Calibration

Connect DMM to the output of the instrument and set the DMM to ACV voltage measurement.

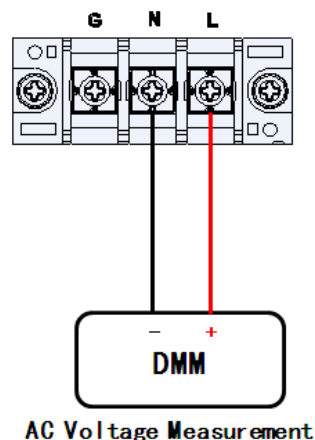



Calibration Vmeas Freq 1				Output Off <input type="radio"/>
Low Point(V)	15.09			Cal.
ADC Count	965	DAC Count	34228	
ML Point(V)	40.22			Freq1
ADC Count	2566	DAC Count	36620	
MH Point(V)	100.59			Freq2
ADC Count	6418	DAC Count	42372	
High Point(V)	261.69			Freq3
ADC Count	16694	DAC Count	57704	
Last Cal.	2000/01/02 01:45			Freq4
Press the Cal. softkey for calibration.				

Calibration is performed for both the 150V range and the 300V range. The following steps repeat for each range:

### 15.1.1 300V range calibration

1. Press **Configure** in the Setting and Measurement screen. Select 300V for the Range (V).

Return to Setting and Measurement screen and select **System** → **Next** → **Calibration** and enter the password **13579**.

2. Select **Vmeas** (AC voltage) on the calibration menu.

Freq1, Freq2, Freq3 and Freq4 represent output frequency of 100Hz, 400Hz, 800Hz and 1200Hz respectively, and calibration is to be performed at each.

3. Press **Freq1** key then press **Cal.** to start calibration. The instrument will output the Low Point voltage.

Use the number keys to enter the voltage shown on the DMM, Press **ENTER**, then the instrument will show "OK" after Low Point(V).

4. Press **Cal.** again to start calibration 2. The instrument will output ML Point voltage.

Use the number keys to enter the voltage shown on the DMM, Press **ENTER** and the instrument will show "OK" after the ML Point(V).

5. Press **Cal.** again to start calibration 3. The instrument will output MH Point voltage.

Use the number keys to enter the voltage shown on the DMM, Press **ENTER** and the instrument will show "OK" after the MH Point(V).

6. Press **Cal.** again to start calibration 4. The instrument will output High Point voltage.

Use the number keys to enter the voltage shown on the DMM, Press **ENTER** and the instrument will show "OK" after the High Point(V).

The calibration date and time will be shown at the bottom of the screen.

Next, calibrate Freq2, Freq3 and Freq4 successively to complete the Range(V) 300V calibration.

### 15.1.2 150V range calibration

Press **ESC** key to return to Setting and Measurement screen and press **Configure**. Select 150V for Range (V). Return to the Setting and Measurement screen, and repeat Steps 2 ~ 3 to calibrate Freq1 through Freq4. Note that the HIGH calibration voltage of 260VAC becomes 140VAC.

### 15.1.3 DC Voltage Calibration

Connect the DMM to the output of the instrument. Set the DMM to DCV voltage measurement.

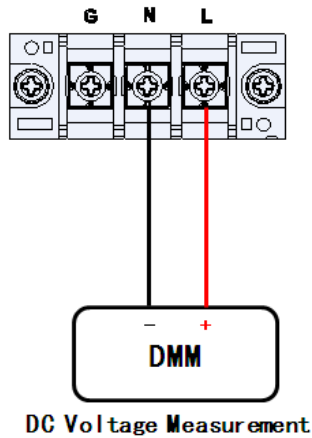

Calibration Vdc				Output Off <input type="radio"/>
Low Point(V)	19.50			Cal.
ADC Count	1221	DAC Count	34156	
ML Point(V)	53.87			
ADC Count	3410	DAC Count	36474	
MH Point(V)	136.11			
ADC Count	8650	DAC Count	42034	
High Point(V)	356.70			
ADC Count	22709	DAC Count	56954	
Last Cal.	2000/01/02 01:49			
Press the Cal. softkey for calibration.				

7. Press **System** → **Next** → **Calibration** → softkeys, Enter the password **13579**, and select **Vdc** (DC voltage) on the calibration menu.
1. Press **Cal.** softkey to start calibration. The instrument will output Low Point voltage. Use the number keys to enter the voltage shown on the DMM. Use the number keys to enter the voltage shown on the DMM. Press **ENTER**, and the instrument will show

“OK” after the Low Point(V).

2. Press **Cal.** softkey to start calibration. The instrument will output ML Point voltage. Use the number keys to enter the voltage shown on the DMM. Use the number keys to enter the voltage shown on the DMM. Press **ENTER**, and the instrument will show “OK” after the ML Point(V).
3. Press **Cal.** softkey to start calibration. The instrument will output MH Point voltage. Use the number keys to enter the voltage shown on the DMM. Use the number keys to enter the voltage shown on the DMM. Press **ENTER**, and the instrument will show “OK” after the MH Point(V).
4. Press **Cal.** softkey to start calibration. The instrument will output High Point voltage. Use the number keys to enter the voltage shown on the DMM. Use the number keys to enter the voltage shown on the DMM. Press **ENTER**, and the instrument will show “OK” after the High Point(V).

The calibration date and time will be shown at the bottom of the screen.

#### 15.1.4 AC Current Calibration

Connect a 3 Ω 5,600 watt resistive load to the output of the instrument, and connect a 0.1 mΩ (rated for 30 A) resistive shunt in series to measure the current.

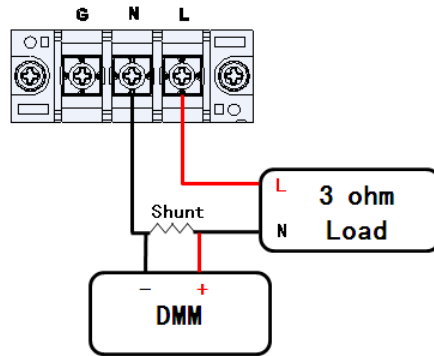

AC Voltage Measurement

Calibration I meas Freq 1				Output Off <input type="radio"/>
Low Point(V)	2.991			Cal.
ADC Count	761	DAC Count	33683	
ML Point(V)	12.018			Freq1
ADC Count	3054	DAC Count	36386	
MH Point(V)	17.919			Freq2
ADC Count	4555	DAC Count	38163	
High Point(V)	24.080			Freq3
ADC Count	6121	DAC Count	40032	
Last Cal.	2000/01/05 23:49			Freq4
Press the Cal. softkey for calibration.				

1. Connect the DMM to both ends of the shunt. Set the DMM to measure AC voltage.
2. Press the **System** → **Next** → **Calibration** → softkeys. Enter the password **13579**.
3. Then select **Imeas** (AC current) on the calibration menu.

Freq1, Freq2, Freq3 and Freq4 represent output frequency of 100Hz, 400Hz, 800Hz and 1200Hz respectively.

5. Press **Freq1** key then press the **Cal.** to start calibration, and the instrument will output the Low Point current.

Divide the voltage shown on the DMM by 3 (3Ω shunt) and use the number keys to enter the result. Press the **ENTER** key when complete. The instrument will show “OK” after Low Point(A).

6. Press **Cal.** softkey to start calibration 2, and the instrument will output the ML Point current.

Divide the voltage shown on the DMM by 3 (3Ω shunt) and use the number keys to enter the result. Press the **ENTER** key when complete. The instrument will show “OK” after the ML Point(A).

7. Press **Cal.** softkey to start calibration 3, and the instrument will output the MH Point current.

Divide the voltage shown on the DMM by 3 (3Ω shunt) and use the number keys to enter the result. Press the **ENTER** key when complete. The instrument will show “OK” after the MH Point(A).

8. Press **Cal.** Softkey to start calibration 4, and the instrument will output the High Point current.

Divide the voltage shown on the DMM by 3 (3Ω shunt) and use the number keys to enter the result. Press the **ENTER** key when complete. The instrument will show “OK” after the High Point(A). The calibration date and time will be shown below.

**Next, calibrate Freq2, Freq3 and Freq4 in order to complete the current calibration.**

### 15.1.5 Restore to Factory Default (RECALL DATA)

If you do not have a device to calibrate the instrument, this step will restore the instrument to the factory defaults.

In Setting and Measurement screen, press **System** → **Next** → **Calibration** → softkeys.

Enter the password **13579** → **RECALL DATA** softkey. Use **◀ ▶** keys (or Rotary) to select **YES**, then press **ENTER** to confirm.

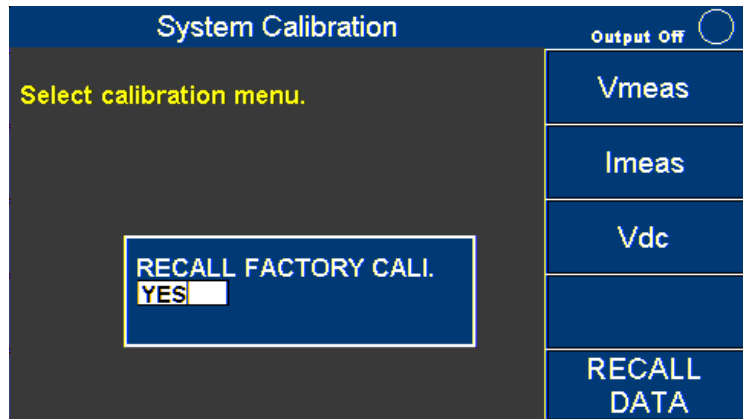

### 15.1.6 External Voltage Calibration

Connect a DC power supply to pin 1 and pin 14 of Digital IO. The DC power must be able to supply 10V.

**CAUTION:**

The DC source for external voltage control and the DC source for external voltage calibration should be identical. And the external voltage calibration should be completed before using external voltage control function.

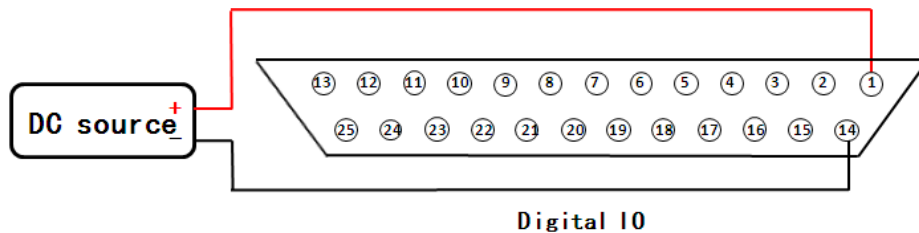

Press **System** → **Next** → **External Calibration** softkeys in Setting and Measurement screen.

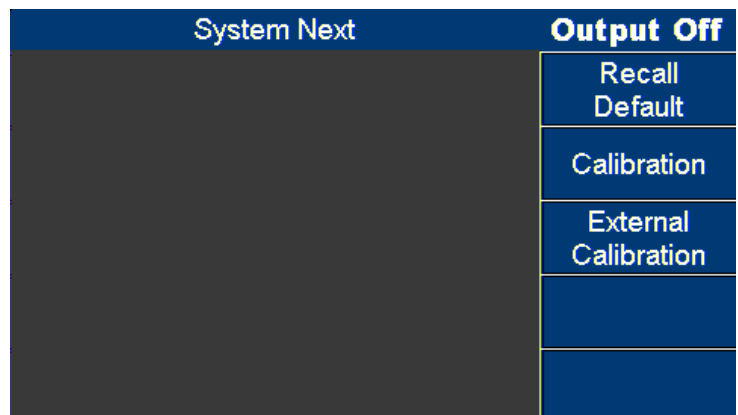

4. Input 9V from the external DC power supply. The ADC value should be  $14900 \pm 300$ , then press the **Next point** softkey to calibrate the second point.

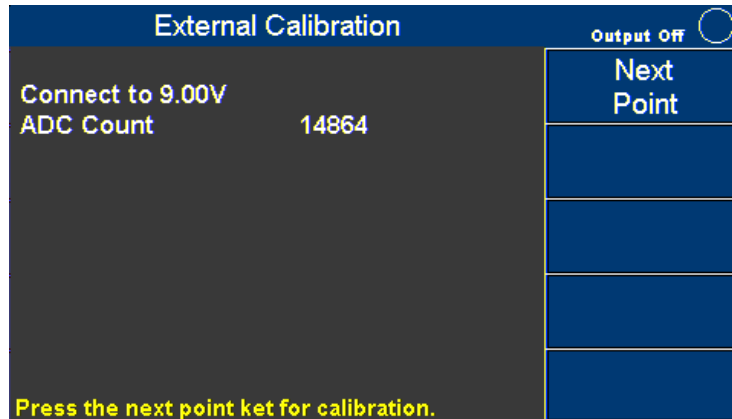

5. Supply 0V from the external DC power supply. The AD value should be  $7900 \pm 300$ , then press the **Next point** softkey to calibrate the third point.

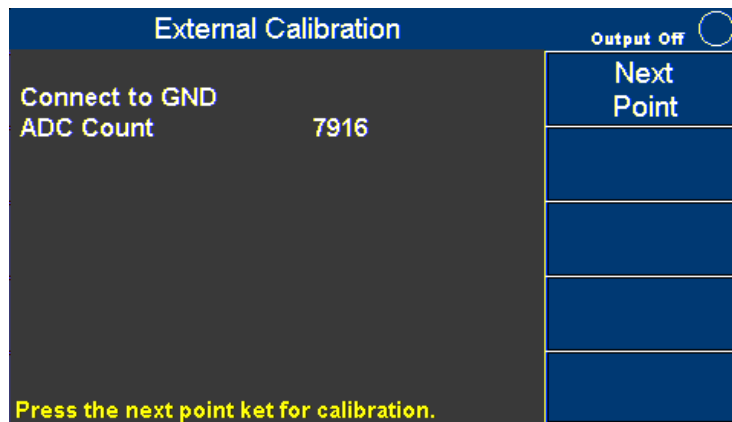

6. Input -9Vdc from the external DC power supply. The AD value should be  $1000 \pm 300$ , then press the **Next point** softkey.

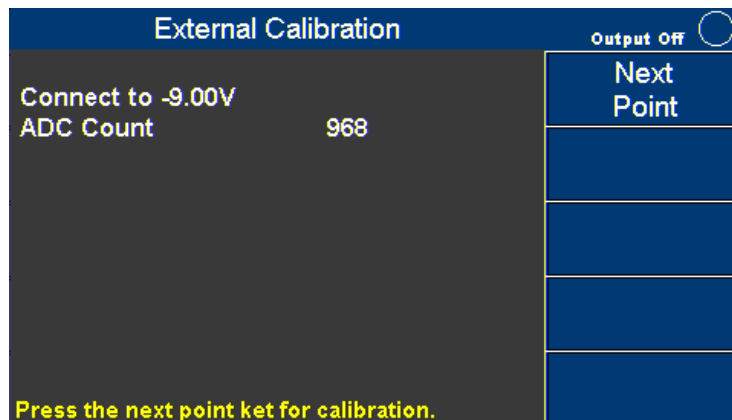

1. The instrument will show "Cal End", then press ESC to complete the external voltage calibration.

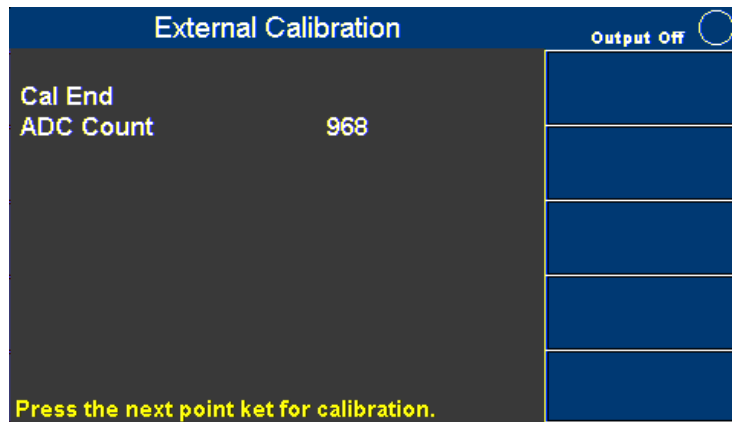

## 16 Specifications

Note: All specifications apply to the unit after a temperature stabilization time of 15 minutes over an ambient temperature range of 23 °C ± 5 °C. Specifications are subject to change without notice.

Model		9832B	9833B
<b>AC Output</b>			
Output Phase		Single	
Max. Power		2000 VA	3000 VA
Voltage Range <sup>1</sup> (rms)	Low	0 to 150 V	
	High	0 to 300 V	
Current (rms)	Low	20 A	30 A
	High	10 A	15 A
Current (peak)	Low	65 A (< 100 Hz)	97.5 A (< 100 Hz)
		50 A (> 100 Hz)	75 A (> 100 Hz)
	High	32.5 A (< 100 Hz)	48.75 A (< 100 Hz)
		25 A (> 100 Hz)	37.5 A (> 100 Hz)
Frequency Range	Single phase	45 Hz to 1.2 kHz	
	3-Phase	45 Hz to 600 Hz	
Phase Range		0 to 359.7	
Total	45 to 400 Hz	0.5 %	
Harmonic	> 400 to 1 KHz	1 %	
Distortion <sup>2</sup>	> 1 k to 1.2 kHz	2 %	
Line Regulation <sup>3</sup>		0.1%	
Load Regulation <sup>3</sup>		0.1% (resistive load)	
Temperature Coefficient		0.02% per °C	
Crest Factor	45 to 100 Hz	3.25	
	100 Hz to 1.2 kHz	2.5	
Efficiency <sup>4</sup>		80 % (typical)	
<b>DC output</b>			
Maxium Power		1000 W	1500 W
Voltage Range <sup>1</sup>	Low	0 to ±212 V	
	High	0 to ±424 V	
Current	Low	10 A	15 A
	High	5 A	7.5 A
Ripple and Noise (20 Hz to 20 MHz)		≤300 mVrms / ≤ 3 Vpp	
<b>Output Characteristics</b>			
Transient Response Time		1.5 ms (typical)	
Output Impedance		≤ 1 ohm	



Programming				
Resolution	Voltage		0.1 V	
	Phase		0.1 degrees	
	Frequency		Hz (< 100 Hz) 0.1 Hz (>100 Hz)	
Accuracy	Voltage	AC	0.2% + 0.2% of F.S.	
		DC	0.2% + 0.4% of F.S.	
	Phase		0.15 %	
	Frequency		± 1 % (45 Hz to 100 Hz)	
Measurement				
Resolution	Voltage		0.1 V	
	Current		0.01 A	
	Power		0.01 W	
	Frequency		0.01 Hz (<100Hz) 0.1 Hz (>100Hz)	
Accuracy	Voltage	AC	0.25 % + 0.25 % F.S.	
		DC	0.25 % + 0.5 % F.S.	
	Current	AC	0.25 % + 0.375 % F.S. (rms) 0.4 % + 0.75 % F.S. (Peak)	0.25 % + 0.25 % F.S. (rms) 0.25% + 0.5 % F.S. (Peak)
		DC	0.25 % + 3 % F.S.	0.25 % + 2 % F.S.
	Power		1 % of F.S. for frequency ≤ 500 Hz 2 % of F.S. for frequency > 500 Hz	
	Frequency		0.5 %	
AC Input				
Voltage		190 to 250V		
Frequency		47 to 63 Hz		
Maximum Power		2500 VA	3800 VA	
Maximum Current		13.2 A	20 A	
Power Factor		0.98 (typical)		
General				
Analog BNC Input	Input Voltage Range Max.		0 to ± 10 V	
	Input Impedance		200 kΩ	
	Bandwidth		1.2 kHz	
Storage Memory		10 programs, up to 100 steps total (list mode) 5 memory locations for user-defined waveforms 9 instrument settings		
Remote Interface		Analog programming <sup>5</sup> , USB (USBTMC or virtual com), RS232 <sup>5</sup> , GPIB, and Ethernet		
Command Response Time		50 ms		
Protection		OVP, OCP, OPP, OTP		

Operating Temperature	32 °F to 104 °F (0 °C to 40 °C)
Storage Temperature	-40 °F to 185 °F (-40 °C to 85 °C)
Environmental Conditions	80% Relative Humidity up to 35 °C, non-condensing
Dimensions ( W×H×D )	16.5" x 5.2" x 22" (420 x 132 x 560 mm)
Weight	52.9 lbs. (24 kg)
Included Accessories	AC power cord with input connector, test report, & certificate of calibration
Optional Accessories	Rackmount ears & handles (RK3U), 3-Phase sync adapter (TL983P), 3-Phase kit (TL983P-KIT)

1 - The maximum voltage is limited to 310 Vrms and  $\pm$  438 Vdc, 3-Phase mode not supported

2 - > 66% to full range

3 - AC mode with sine wave and remote sense enabled

4 - 150 VAC (150 V range) and 300 VAC (300 V range) with nominal input AC voltage.

5 – Analog programming pin available on digital I/O connector, not available in 3-Phase.

## **17 LIMITED THREE-YEAR WARRANTY**

---

B&K Precision Corp. warrants to the original purchaser that its products and the component parts thereof, will be free from defects in workmanship and materials for a period of three years from date of purchase.

B&K Precision Corp. will, without charge, repair or replace, at its option, defective product or component parts. Returned product must be accompanied by proof of the purchase date in the form of a sales receipt.

To help us better serve you, please complete the warranty registration for your new instrument via our website [www.bkprecision.com](http://www.bkprecision.com)

**Exclusions: This warranty does not apply in the event of misuse or abuse of the product or as a result of unauthorized alterations or repairs. The warranty is void if the serial number is altered, defaced or removed.**

B&K Precision Corp. shall not be liable for any consequential damages, including without limitation damages resulting from loss of use. Some states do not allow limitations of incidental or consequential damages. So the above limitation or exclusion may not apply to you.

This warranty gives you specific rights and you may have other rights, which vary from state-to-state.

B&K Precision Corp.  
22820 Savi Ranch Parkway  
Yorba Linda, CA 92887  
[www.bkprecision.com](http://www.bkprecision.com)  
714-921-9095



22820 Savi Ranch Parkway

Yorba Linda, CA 92887

[www.bkprecision.com](http://www.bkprecision.com)

© 2020 B&K Precision Corp.