

BK PRECISION®

Model: 4052, 4053, 4054, 4055

Function/Arbitrary Waveform Generator

USER MANUAL



Safety Summary

The following safety precautions apply to both operating and maintenance personnel and must be observed during all phases of operation, service, and repair of this instrument. Before applying power, follow the installation instructions and become familiar with the operating instructions for this instrument.

If this device is damaged or something is missing, contact the place of purchase immediately.

This manual contains information and warnings that must be followed to ensure safe operation as well as maintain the meter in a safe condition.

GROUND THE INSTRUMENT

To minimize shock hazard, the instrument chassis and cabinet must be connected to an electrical ground. This instrument is grounded through the ground conductor of the supplied, three-conductor ac power cable. The power cable must be plugged into an approved three-conductor electrical outlet. Do not alter the ground connection. Without the protective ground connection, all accessible conductive parts (including control knobs) can render an electric shock. The power jack and mating plug of the power cable must meet IEC safety standards.

DO NOT OPERATE IN AN EXPLOSIVE ATMOSPHERE

Do not operate the instrument in the presence of flammable gases or fumes. Operation of any electrical instrument in such an environment constitutes a definite safety hazard.

KEEP AWAY FROM LIVE CIRCUITS

Instrument covers must not be removed by operating personnel. Component replacement and internal adjustments must be made by qualified maintenance personnel. Disconnect the power cord before removing the instrument covers and replacing components. Under certain conditions, even with the power cable removed, dangerous voltages may exist. To avoid injuries, always disconnect power and discharge circuits before touching them.

DO NOT SERVICE OR ADJUST ALONE

Do not attempt any internal service or adjustment unless another person, capable of rendering first aid and resuscitation, is present.

DO NOT SUBSTITUTE PARTS OR MODIFY THE INSTRUMENT

Do not install substitute parts or perform any unauthorized modifications to this instrument. Return the instrument to B&K Precision for service and repair to ensure that safety features are maintained.

WARNINGS AND CAUTIONS

WARNING and **CAUTION** statements, such as the following examples, denote a hazard and appear throughout this manual. Follow all instructions contained in these statements.

A **WARNING** statement calls attention to an operating procedure, practice, or condition, which, if not followed correctly, could result in injury or death to personnel.

A **CAUTION** statement calls attention to an operating procedure, practice, or condition, which, if not followed correctly, could result in damage to or destruction of part or all of the product.

WARNING: *Do not alter the ground connection. Without the protective ground connection, all accessible conductive parts (including control knobs) can render an electric shock. The power jack and mating plug of the power cable meet IEC safety standards.*

WARNING: *To avoid electrical shock hazard, disconnect power cord before removing covers. Refer servicing to qualified personnel.*

CAUTION: *Before connecting the line cord to the AC mains, check the rear panel AC line voltage indicator. Applying a line voltage other than the indicated voltage can destroy the AC line fuses. For continued fire protection, replace fuses only with those of the specified voltage and current ratings.*

CAUTION: *This product uses components which can be damaged by electro-static discharge (ESD). To avoid damage, be sure to follow proper procedures for handling, storing and transporting parts and subassemblies which contain ESD-sensitive components.*

Compliance Statements

Disposal of Old Electrical & Electronic Equipment (Applicable in the European Union and other European countries with separate collection systems)

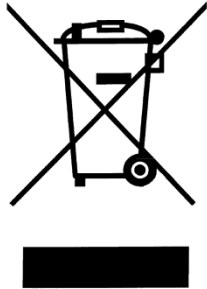

This product is subject to Directive 2002/96/EC of the European Parliament and the Council of the European Union on waste electrical and electronic equipment (WEEE) , and in jurisdictions adopting that Directive, is marked as being put on the market after August 13, 2005, and should not be disposed of as unsorted municipal waste. Please utilize your local WEEE collection facilities in the disposition of this product and otherwise observe all applicable requirements.

CE Declaration of Conformity

The power supply meets the requirements of 2006/95/EC Low Voltage Directive and 2004/108/EC Electromagnetic Compatibility Directive with the following standards.







Low Voltage Directive

- EN61010-1: 2001
- EN61010-031: 2002+A1: 2008

EMC Directive

- EN 61326-1:2006
- EN 61000-3-2: 2006+A2: 2009
- EN 61000-3-3: 2008

Safety Symbols

	Refer to the user manual for warning information to avoid hazard or personal injury and prevent damage to instrument.
	Chassis (earth ground) symbol.
	On (Power). This is the In position of the power switch when instrument is ON.
	Off (Power). This is the Out position of the power switch when instrument is OFF.
	On (Supply). This is the AC mains connect/disconnect switch at the back of the instrument.
	Off (Supply). This is the AC mains connect/disconnect switch at the back of the instrument.

Notations

TEXT - Denotes a front panel button.

TEXT – Denotes a menu option.

Table of Contents

1	General Information	9
1.1	Product Overview	9
1.2	Package Contents	9
1.3	Front Panel Overview	10
	<i>Front Panel Description</i>	<i>10</i>
1.4	Rear Panel Overview	11
	<i>Rear Panel Description</i>	<i>11</i>
1.5	Display Overview	12
	<i>Display Description.....</i>	<i>12</i>
2	Getting Started	12
2.1	Input Power Requirements	12
	<i>Input Power.....</i>	<i>12</i>
2.2	Output Connections	13
	<i>Impedance Matching</i>	<i>13</i>
2.3	Preliminary Check.....	14
	<i>Check Model and Firmware Version</i>	<i>16</i>
	<i>Output Check.....</i>	<i>16</i>
3	Front Panel Operation	17
3.1	Menu Options.....	17
3.2	Selecting a Channel	20
3.3	Configure Waveform Output.....	20
	<i>Configure Waveform Shape</i>	<i>20</i>
	<i>Configure Frequency</i>	<i>22</i>
	<i>Configure Amplitude</i>	<i>22</i>
	<i>Configure DC Offset.....</i>	<i>24</i>
	<i>Configure Phase</i>	<i>24</i>
	<i>Configure Duty Cycle and Symmetry.....</i>	<i>25</i>
	<i>Configure Pulse Waveform.....</i>	<i>27</i>
	<i>Configure Noise Waveform</i>	<i>29</i>
	<i>Configure Arbitrary Waveform</i>	<i>30</i>
	<i>Configure DC Output.....</i>	<i>33</i>
3.4	Configure Modulation	34
	<i>AM Modulation</i>	<i>34</i>

DSB-AM	35
ASK (Amplitude Shift Keying)	37
FM Modulation	38
FSK (Frequency Shift Keying)	39
PM Modulation	40
PWM Modulation.....	41
3.5 Configure Sweep Output	43
3.6 Configure Burst.....	46
3.7 Store and Recall.....	49
<i>Accessing Store/Recall Menu</i>	50
<i>Store and Recall Instrument State</i>	51
<i>Store and Recall Arbitrary Waveforms</i>	53
3.8 Utility Functions	55
<i>DC Waveform Output</i>	55
<i>Remote Interface</i>	56
<i>Output Configurations</i>	57
<i>Frequency Counter</i>	60
3.9 System Configurations.....	62
<i>System Settings</i>	63
<i>Self Test and Adjustment</i>	67
<i>Check Instrument Information</i>	67
<i>Updating Firmware</i>	67
3.10 Help System	68
4 Troubleshooting Guide	69
5 Specifications	70
SERVICE INFORMATION.....	75
LIMITED ONE-YEAR WARRANTY	76

1 General Information

1.1 Product Overview

The B&K Precision 4050 series are dual channel function / arbitrary waveform generators, capable of generating up to 50 MHz sine wave (model 4055). They have an informative easy-to-read color display, user-friendly controls and a numeric keypad which allows users to easily configure waveform properties. In addition, they feature non-volatile built-in memory to create, store, and recall arbitrary waveforms up to 16,000 points with 14-bit vertical resolution. 48 predefined arbitrary waveforms are also available for output. A standard USB interface on the rear panel allows users to easily interface with application software to create and load arbitrary waveforms into the instrument.

Features:

- Generate sine wave from 1 μ Hz up to 50 MHz (4055)
- 3.5-inch TFT-LCD color display
- USB interface
- 16k pts arbitrary waveform memory
- 48 built-in predefined arbitrary waveforms
- Store/recall up to 10 instrument settings

1.2 Package Contents

Please inspect the instrument mechanically and electrically upon receiving it. Unpack all items from the shipping carton, and check for any obvious signs of physical damage that may have occurred during transportation. Report any damage to the shipping agent immediately. Save the original packing carton for possible future reshipment. Every instrument is shipped with the following contents:

- **4050 series function/arbitrary waveform generator**
- **Getting started manual (printed)**
- **Full instruction manual on CD**
- **AC power cord**
- **USB type A to Type B cable**
- **Certificate of calibration**

Verify that all items above are included in the shipping container. If anything is missing, please contact B&K Precision.

An optional USB to GPIB adapter model AK40G is also available

1.3 Front Panel Overview

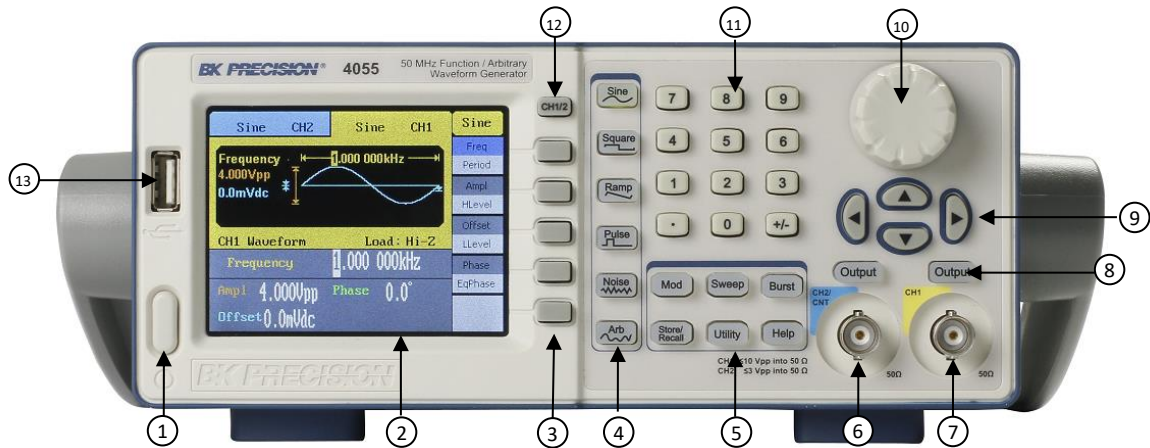

Front Panel Description

①	Power On/Off switch
②	TFT LCD color display
③	Menu function keys
④	Waveform buttons
⑤	Modulation/Sweep/Burst/Store-Recall/Utility/Help menu buttons
⑥	Channel 2 output BNC / Counter input
⑦	Channel 1 output BNC
⑧	Channel 1 and 2 output On/Off buttons
⑨	Arrow keys
⑩	Rotary dial knob
⑪	Numeric keypad
⑫	Channel selection button
⑬	USB host port / *USB-to-GPIB adapter interface <i>Accepts USB flash drive to save/recall instrument settings and waveforms. *This port can be used for connecting the USB-to-GPIB adapter (AK40G) accessory. It can also be used for connecting an external USB flash drive.</i>

1.4 Rear Panel Overview

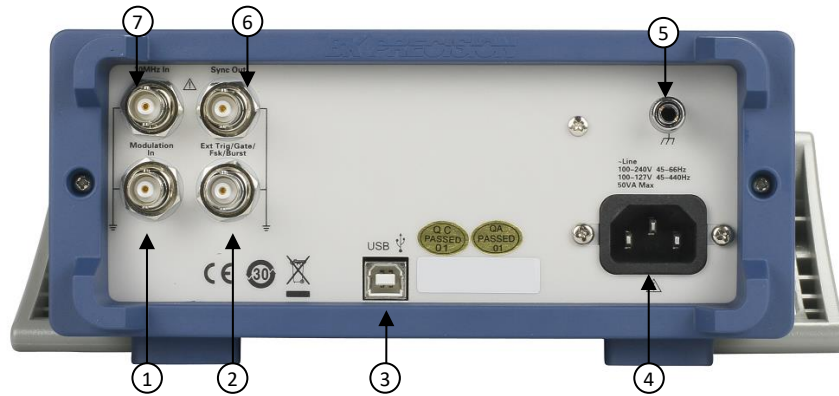

Rear Panel Description

-
- ① Modulation Input BNC

 - ② External Trigger/Gate/FSK/Burst BNC Connector

 - ③ USB interface

 - ④ AC input receptacle

 - ⑤ Chassis ground

 - ⑥ Sync Output BNC

 - ⑦ Trigger Input BNC

1.5 Display Overview

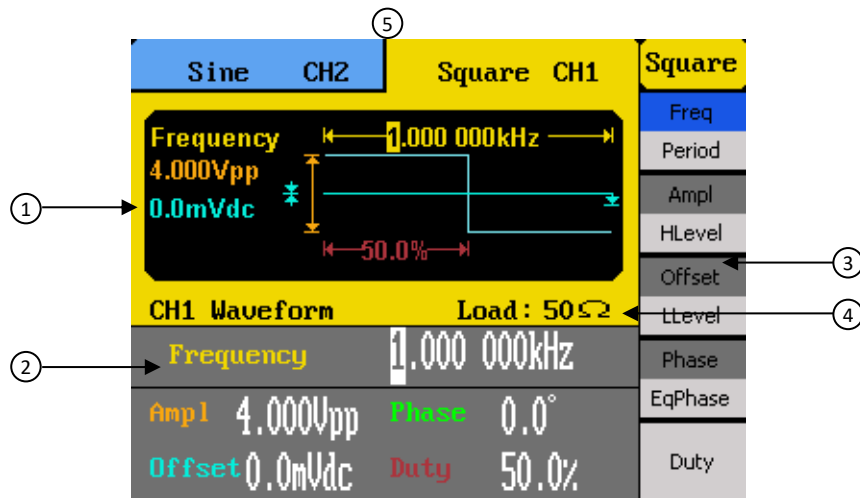

Display Description

①	Waveform information display
②	Waveform parameters display
③	Menu options
④	Output impedance indicator
⑤	Selected channel indicator tab

2 Getting Started

Before connecting and powering up the instrument, please review and go through the instructions in this chapter.

2.1 Input Power Requirements

Input Power

The supply has a universal AC input that accepts line voltage and frequency input within:

100 – 240 V (+/- 10%), 50 – 60 Hz (+/- 5%)
 100 – 127 V , 45 – 440 Hz

Before connecting to an AC outlet or external power source, be sure that the power switch is in the OFF position and verify that the AC power cord, including the extension line, is compatible with the rated voltage/current and that there is sufficient circuit capacity for the power supply. Once verified, connect the cable firmly.

WARNING:

The included AC power cord is safety certified for this instrument operating in rated range. To change a cable or add an extension cable, be sure that it can meet the required power ratings for this instrument. Any misuse with wrong or unsafe cables will void the warranty.

2.2 Output Connections

The waveform generator output circuits operate as a 50 Ω voltage source working into a 50 Ω load. At higher frequencies, a non-terminated or improperly terminated output may cause aberrations on the output waveform. In addition, loads with an impedance less than 50 Ω will reduce the waveform amplitude, while loads with an impedance greater than 50 Ω will increase waveform amplitude.

Excessive distortion or aberrations caused by improper termination are less noticeable at lower frequencies, especially with sine and triangle waveforms. To ensure waveform integrity, follow these precautions:

1. Use good quality 50 Ω coaxial cable and connectors.
2. Make all connections tight and as short as possible.
3. Use good quality attenuators, if it is necessary to reduce waveform amplitudes applied to sensitive circuits.
4. Use termination or impedance-matching devices to avoid reflections.
5. Ensure that attenuators and terminations have adequate power handling capabilities.

If there is a DC voltage across the output load, use a coupling capacitor in series with the load. The time constant of the coupling capacitor and load must be long enough to maintain pulse flatness.

Impedance Matching

If the waveform generator is driving a high impedance, such as a 1 M Ω input impedance (paralleled by a stated capacitance) of an oscilloscope vertical input, connect the transmission line to a 50 Ω attenuator, a 50 Ω termination and to the oscilloscope input. The attenuator isolates the input capacitance of the device and terminates the waveform generator properly.

2.3 Preliminary Check

Complete the following steps to verify that the generator is ready for use.

1. Verify AC Input Voltage

Verify and check to make sure proper AC voltages are available to power the instrument. The AC voltage range must meet the acceptable specification as explained in section 2.1.

2. Connect Power

Connect AC power cord to the AC receptacle in the rear panel and press the power switch to the ON position to turn ON the instrument. The instrument will have a boot screen while loading, after which the main screen will be displayed.

3. Self Test

Press **Utility**, select **1/2** from the menu to enter the second menu page, and select **Test/Cal** option. Then, select **SelfTest** option. The instrument has 3 self test options to test the screen, keys, and the LED back lights of the function, menu, and channel output keys.

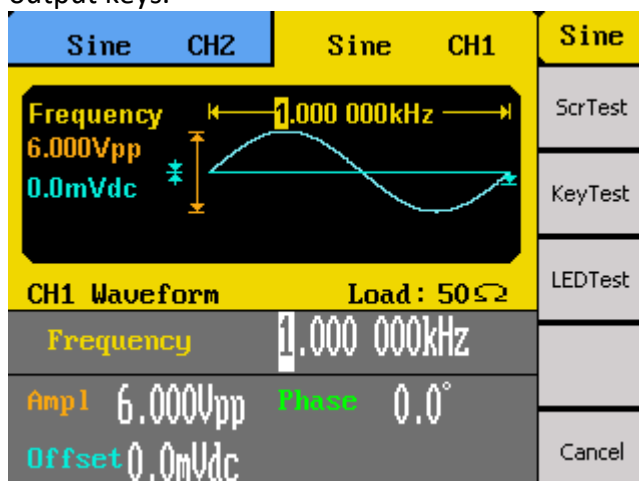

ScrTest Select this option to do a screen test. The screen will turn into a solid color background.

Press '7' key to continue,
Press '8' key to exit.

Press **7** to toggle through red, green, and blue colors. This test checks for dead pixels and color consistencies of the TFT LCD display. Press **8** to exit the test.

KeyTest Select this option to do a key test. The screen will display a silhouette of buttons that represent the front panel buttons.

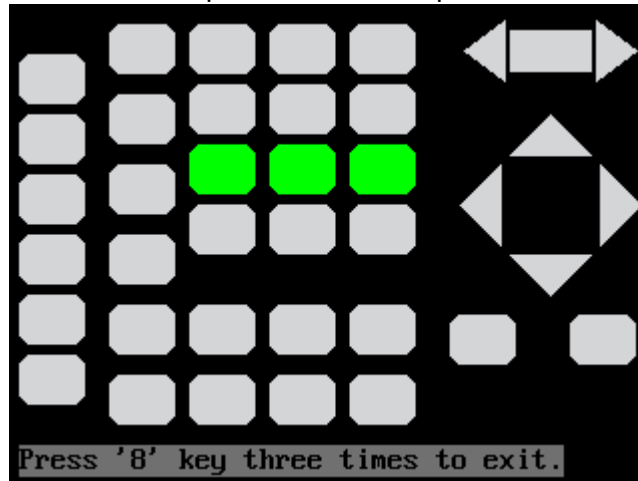

Press any of the front panel buttons and its corresponding button in the silhouette will turn green. This tests the key press response. If any of the buttons do not change colors on the silhouette when pressed, there may be something faulty with the key. Press **8** three times to exit the test.

LEDTest Select this option to test the function, menu, and channel output buttons' backlight.

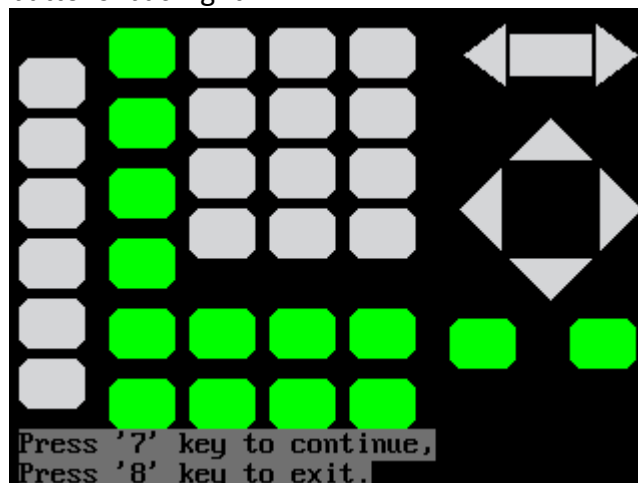

Like the key test, the screen will display a silhouette of buttons that represent the front panel buttons. Press **7** to begin the test. This test will start with the **Sine** button, which should light up. Its corresponding button in the silhouette should also turn green. Continue to press **7** to toggle through all the buttons with backlights available. At the end of the test, all function, menu, and channel output buttons will light up, and all of their corresponding buttons in the silhouette on the display will turn green. Press **8** to exit the test.

4. Self Adjust

This option runs an internal self adjustment procedure that will check and adjust the instrument to specification. Use this option only if the instrument is suspected to be out of calibration.

Press **Utility**, select **1/2** from the menu to enter the second menu page, and select **Test/Cal** option. Then, select **SelfAdjust** option. The instrument will run the procedure internally, and a progress bar will be displayed in the waveform information area. When finished, it will show 100% on the progress bar and prompt you to press any function key to continue. Follow the prompt to return to the main display.

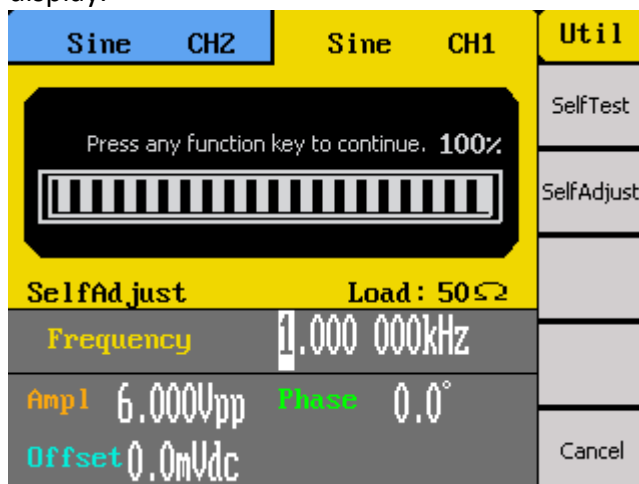

Check Model and Firmware Version

The model and firmware version can be verified from within the menu system.

Press **Utility**, select **1/2** from the menu to enter the second menu page, and select **EditInfo** option. The software/firmware version, hardware version, model, and serial number will be displayed. Press any function key to exit.

Output Check

Follow the steps below to do a quick check of the settings and waveform output.

1. Turn on the instrument and set the instrument to default settings. To set to default, press **Utility**, press **1/2** to go to page 2, select **System** from the menu, and select **Set to Default**. The instrument will set both channels with the following parameters:

Waveform Shape: **Sine**

Frequency: **1.000000 kHz**

Amplitude: **4.000 Vpp**

Offset: **0.0 mVdc**

Phase: **0.0 °**

Output Impedance: **Hi-Z**

2. Connect the BNC output of CH1 (yellow) into an oscilloscope.
3. Press the **Output** button on top of CH1 output BNC to turn on the output and observe a sine wave with the parameters above.
4. Press the **Freq** or **Period** option in the menu and use the rotary knob or the numeric keypad to change frequency. Observe the changes on the oscilloscope display.
5. Press the **Ampl** option in the menu and use the rotary knob or the numeric keypad to change the amplitude. Observe the changes on the oscilloscope display.
6. Press the **Offset** option in the menu and use the rotary knob or the numeric keypad to change the DC offset. With the oscilloscope set for DC coupling, observe the changes on the display.
7. Now, connect the BNC output of CH2 (blue) into an oscilloscope and follow steps 3 to 6 to check its output.

3 Front Panel Operation

3.1 Menu Options

All settings and parameters can be configured from the menu system of the instrument. The menu options that are channel specific are the same for both channel 1 and channel 2. Use the CH1/2 key to toggle the channel selection.

Some many options are grouped in pairs and can be selected by toggling their corresponding menu function keys. For example:

Freq	Function key will toggle selection between frequency or period .
Period	
Ampl	Function key will toggle selection between amplitude or HI level .
HLevel	
Offset	Function key will toggle selection between DC offset or LO level .
LLevel	
Phase	Function key will toggle selection between phase or equal phase .
EqPhase	
1/2 ↓	Function key will go to page 2/2 menu.

The menu system is organized as follows:

Sine

- Freq/Period** Configures the frequency or period of the waveform.
- Ampl/HLevel** Configures the amplitude or the high level of the waveform.
- Offset/LLevel** Configures the DC offset or the low level of the waveform.

	Phase/EqPhase	Configures the phase or set equal phase relative to the other channel.	
Square	Freq/Period	Configures the frequency or period of the waveform.	
	Ampl/HLevel	Configures the amplitude or the high level of the waveform.	
	Offset/LLevel	Configures the DC offset or the low level of the waveform.	
	Phase/EqPhase	Configures the phase or set equal phase relative to the other channel.	
	Duty	Configures the duty cycle of the waveform.	
Ramp	Freq/Period	Configures the frequency or period of the waveform.	
	Ampl/HLevel	Configures the amplitude or the high level of the waveform.	
	Offset/LLevel	Configures the DC offset or the low level of the waveform.	
	Phase/EqPhase	Configures the phase or set equal phase relative to the other channel.	
	Symmetry	Configures the symmetry of the waveform.	
Pulse	Freq/Period	Configures the frequency or period of the waveform.	
	Ampl/HLevel	Configures the amplitude or the high level of the waveform.	
	Offset/LLevel	Configures the DC offset or the low level of the waveform.	
	PulWidth/Duty	Configures the pulse width or the duty cycle of the pulse.	
	Delay	Configures the delay of the pulse waveform.	
Noise	Stdev	Configures the standard deviation of the noise waveform.	
	Mean	Configures the mean value of the noise waveform.	
Arb	Freq/Period	Configures the frequency or period of the waveform.	
	Ampl/HLevel	Configures the amplitude or the high level of the waveform.	
	Offset/LLevel	Configures the DC offset or the low level of the waveform.	
	Phase/EqPhase	Configures the phase or set equal phase relative to the other channel.	
	Load Wforms	Built-In – Access selectable built-in waveforms for output. Stored Wforms – Access arbitrary waveforms stored in internal memory for output.	
Mod	AM Freq/AM Depth/DSB	Configures parameters for AM, FM, PM, ASK, FSK, DSB-AM, PWM modulation.	
	Freq/Key		
	Freq/FM		
	Freq/FM		
	Dev/PM		
	Freq/Phase		
	Dev/PWM		
	Freq/Width		
	Dev		
	Type		Configures the type of modulation.
	Shape		Configures the modulating waveform shape.
	Source		Selects modulating source.
Sweep			

	SwpTime	Configures the sweep time for sweep output.
	StopFreq/FrqSpan	Configures the sweep stop frequency or the frequency span of the sweep output.
	StartFreq/MidFreq	Configures the sweep start frequency or the center frequency.
	Source	Selects the sweep source.
	Trig Out/Edge	Internal source: Selects to output a trigger signal at the start of a sweep operation. External source: Selects to use rising or falling edge from an external trigger for sweep operation.
	Linear/Log Direction	Selects between linear or logarithmic sweep operation.
	Trig	Selects the sweep direction
		Manually triggers the sweep operation if the source is set to manual.
Burst		
	Period	Configures the burst period.
	StartPhase	Configures the start phase of the burst output.
	Ncycle/Gated	Selects to burst by number of cycles or selects for external gated burst.
	Source/Polarity	Selects the source for burst output or selects the polarity for external gated burst output.
	Trig Out Cycles/Infinite	Selects signal triggering on rising or falling edge. Configures number of cycles for burst or infinite burst (external source only).
	Delay	Configures the delay of each burst.
Store/Recall		
	FileType	Selects the type of files for save/recall.
	Browser Save	Selects to browser through folders or files on display. Saves the selected file into internal or external USB flash memory.
	Recall	Recalls the selected file from internal or external USB flash memory.
	Delete	Select to delete the selection.
Utility		
	DC	Selects to toggle ON/OFF a DC output. Selectable DC voltages are: 1 V, -1 V, 2 V, -2 V, 5 V, -5 V.
	Interface	Selects the remote interface. .
	Output Setup	Load – Select output impedance. Normal/Invert – Select to toggle between normal and inverted output. CHCopy – Copy channel settings between channels. Sync – Select to enable/disable synchronization output with respect to either channel 1 or 2.
	Counter	Selects built-in counter function.
	System	Access to system settings.
	Test/Cal	Built-in self test and adjustment options.
	EditInfo	Shows information about the generator.
	Update	For firmware updates.

Help

3.2 Selecting a Channel

The 4050 series function/arbitrary waveform generators have dual channel outputs. They can be operated independently or in sync with each other. To select between channel 1 and 2 and view/change their parameters, toggle the CH1/2 key.

When **Channel 1** is selected, the display will look like below:

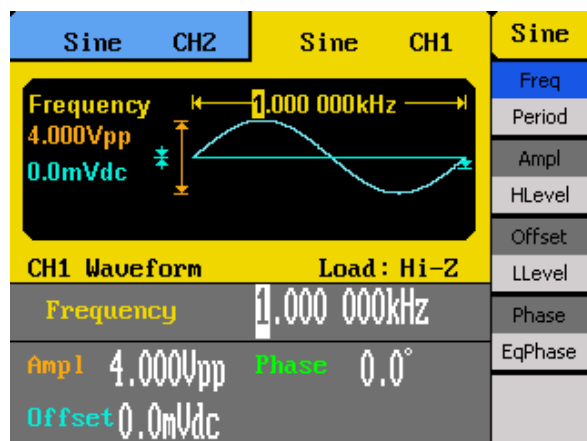

When **Channel 2** is selected, the display will look like below:

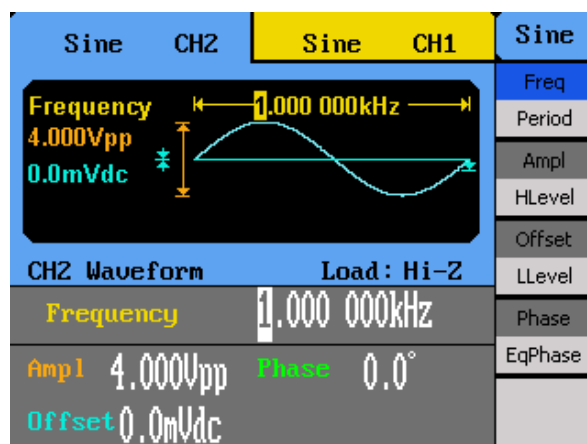

3.3 Configure Waveform Output

Configure Waveform Shape

The instrument can generate many standard as well as arbitrary waveforms. There are waveform keys on the front panel that will switch between different waveform shape to output. Below is a table of waveforms and the corresponding keys to press to generate those waveforms.

Waveforms	Keys
Sine	Sine
Square	Square
Ramp	Ramp
Pulse	Pulse
Noise	Noise
Arbitrary	Arb

After the waveform selection, menu options relevant for that waveform shape will be shown on the right side of the display. Below illustrates the screenshots shown when each of the waveform types is selected.

<p>Sine Waveform</p> <p>Sine CH2 Sine CH1 Sine</p> <p>CH1 Waveform Load: Hi-Z</p> <p>Frequency 1.000 000kHz</p> <p>Ampl 4.000Vpp Phase 0.0°</p> <p>Offset 0.0mVdc</p>	<p>Square Waveform</p> <p>Sine CH2 Square CH1 Square</p> <p>CH1 Waveform Load: 50Ω</p> <p>Frequency 1.000 000kHz</p> <p>Ampl 4.000Vpp Phase 0.0°</p> <p>Offset 0.0mVdc Duty 50.0%</p>
<p>Ramp Waveform</p> <p>Ramp CH2 Ramp CH1 Ramp</p> <p>CH1 Waveform Load: Hi-Z</p> <p>Frequency 1.000 000kHz</p> <p>Ampl 4.000Vpp Phase 0.0°</p> <p>Offset 0.0mVdc Syme 50.0%</p>	<p>Pulse Waveform</p> <p>Ramp CH2 Pulse CH1 Pulse</p> <p>CH1 Waveform Load: Hi-Z</p> <p>Frequency 1.000 000kHz</p> <p>Ampl 4.000Vpp Width 200.0us</p> <p>Offset 0.0mVdc Delay 0.0us</p>
<p>Noise Waveform</p> <p>Ramp CH2 Noise CH1 Noise</p> <p>CH1 Waveform Load: Hi-Z</p> <p>Stdev 25.0mV</p> <p>Mean 0.000V</p>	<p>Arbitrary Waveform</p> <p>Ramp CH2 Arb CH1 Arb</p> <p>CH1 Waveform Load: Hi-Z</p> <p>Frequency 1.000 000kHz</p> <p>Ampl 4.000Vpp Phase 0.0°</p> <p>Offset 0.0mVdc</p>

Configure Frequency

Note: This section does not apply for noise waveform.

Follow the steps below to configure the frequency or period of the output. The adjustable frequency range is different for each model and for each type of waveforms. See the specification section for the adjustable ranges.

1. After selecting the waveform shape, there will be a **Freq/Period** menu option. Press the corresponding menu function key to toggle between selecting frequency or the period to adjust.
2. The cursor position will now highlight the first digit of the frequency parameter display.
3. Use the rotary knob or the numeric keypad to change the frequency. If numeric keypad is used, the below screen will display:

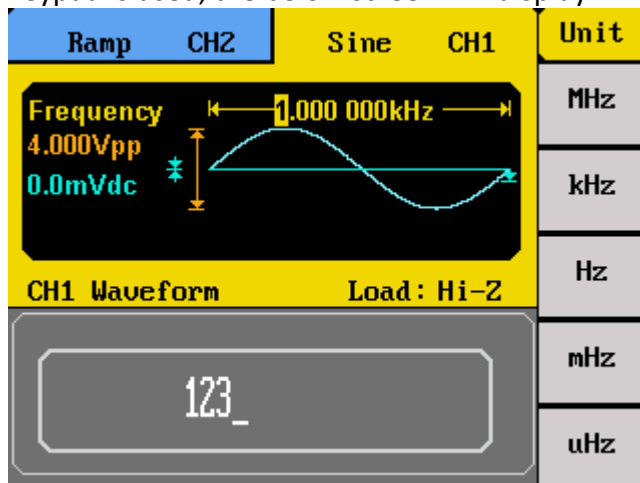

After entering the numeric value, use the menu function keys to select the unit to apply for the frequency setting. Available units are: **MHz, kHz, Hz, mHz, uHz**.

Configure Amplitude

Note: This section does not apply for noise waveform.

Follow the steps below to configure the amplitude of the output. The adjustable amplitude range for **Channel 1** is **2 mVpp – 10 Vpp into 50 Ω , or 4 mVpp – 20 Vpp into HighZ**. For **Channel 2**, it is **2 mVpp – 3 Vpp into 50 Ω , or 4 mVpp – 6 Vpp into HighZ**.

1. From the menu, select **Ampl**.
2. The cursor position will now highlight the first digit of the amplitude parameter display.
3. Use the rotary knob or the numeric keypad to change the amplitude. If numeric keypad is used, the below screen will display:

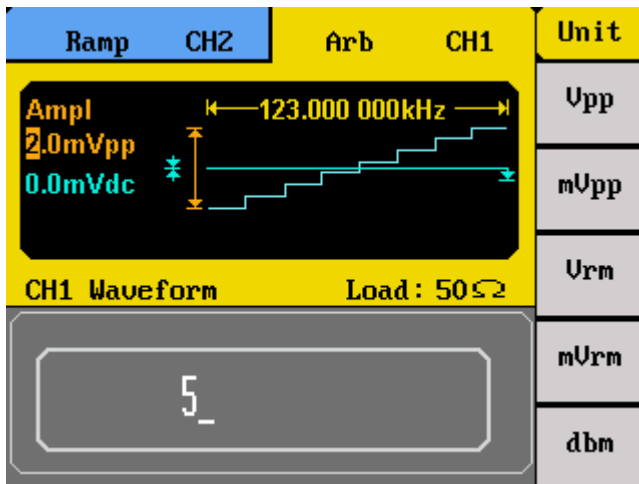

After entering the numeric value, use the menu function keys to select the unit to apply for the amplitude setting. Available units are: **Vpp**, **mVpp**, **Vrm**, **mVrm**, **dbm**. **Vrm** is for Vrms and **mVrm** is for mVrms.

Note: Only using the numeric keypad will allow for changing the units from V to Vrms, mVrms, or dbm.

User Defined High and Low Level

The user has the option to adjust the high and low level of the waveform. To do this, toggle the menu function key to select **HLevel** for high level or **LLevel** for low level.

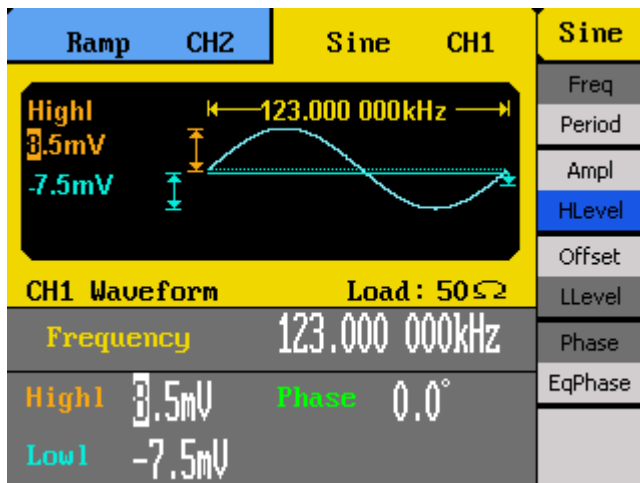

Note: DC offset settings will be automatically adjusted if the high and low levels reflect a DC offset.

Configure DC Offset

Note: This section does not apply for noise waveform.

Follow the steps below to configure the DC offset of the output.

1. From the menu, select **Offset**.
2. The cursor position will now highlight the first digit of the offset parameter display.
3. Use the rotary knob or the numeric keypad to change the offset. If numeric keypad is used, the below screen will display:

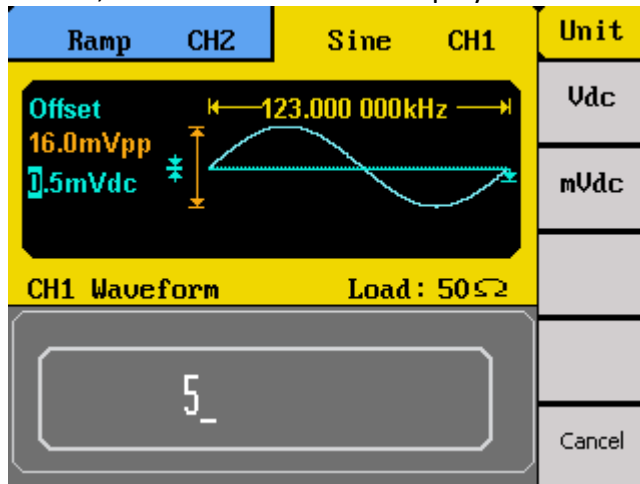

After entering the numeric value, use the menu function keys to select the unit to apply for the offset setting. Available units are: **Vdc**, **mVdc**.

Configure Phase

Note: This section does not apply for pulse and noise waveforms.

Follow the steps below to configure the phase of the output.

1. From the menu, select **Phase**.
2. The cursor position will now highlight the first digit of the phase parameter display.
3. Use the rotary knob or the numeric keypad to change the phase. If numeric keypad is used, the below screen will display:

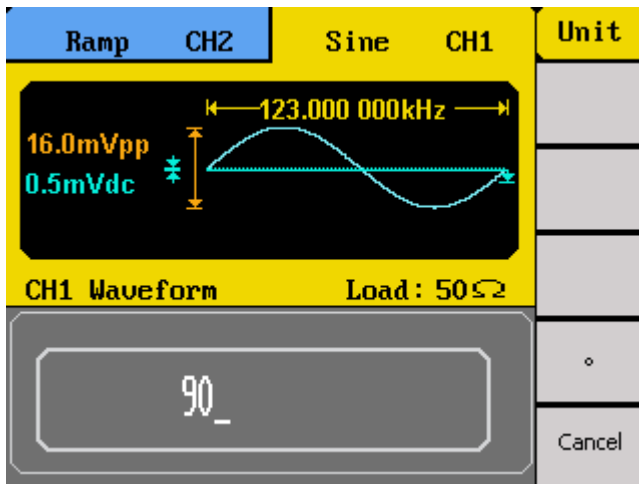

After entering the numeric value, use the menu function keys to select the degree (°) unit to apply for the phase setting.

Equal Phase

The unit can set both channel 1 and channel 2 to be in phase with a push of one button. From the menu, simply select **EqPhase** and both channels will be in-phase with respect to each other.

Configure Duty Cycle and Symmetry

Note: This section does not apply for pulse and noise waveforms.

Duty Cycle

Note: For square waveform only.

Follow the steps below to configure the duty cycle of a square waveform.

1. Set the instrument for square wave output by pressing the **Square** button.
2. From the menu, select **Duty**.
3. The cursor position will now highlight the first digit of the duty parameter display.

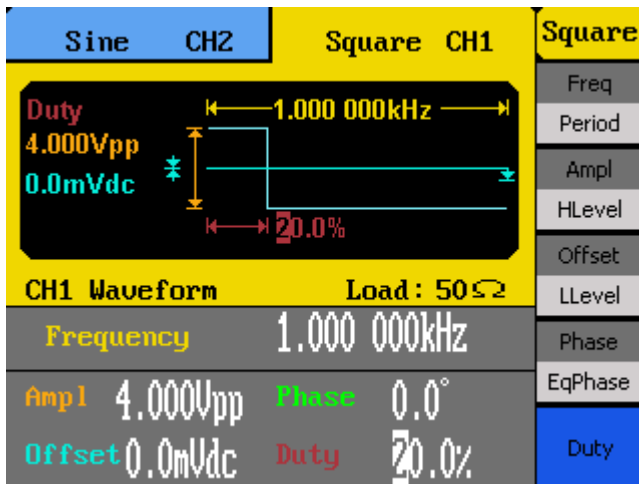

- Use the rotary knob or the numeric keypad to change the duty cycle. If numeric keypad is used, the below screen will display:

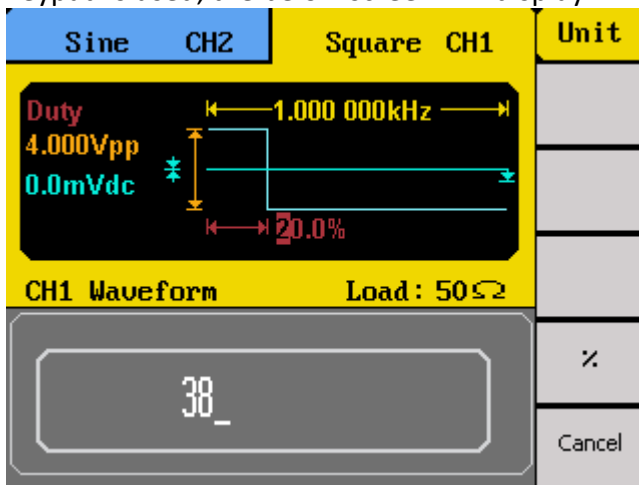

After entering the numeric value, use the menu function keys to select the percent (%) unit to apply for the duty cycle setting.

Note: The adjustable duty cycle range varies depending on the frequency of the waveform. Some frequencies do not allow change of the duty cycle and is fixed at 50%.

Symmetry

Note: For ramp/triangle waveform only.

Follow the steps below to configure the symmetry of a ramp/triangle waveform.

- Set the instrument for ramp wave output by pressing the **Ramp** button.
- From the menu, select **Symmetry**.
- The cursor position will now highlight the first digit of the symmetry parameter display.

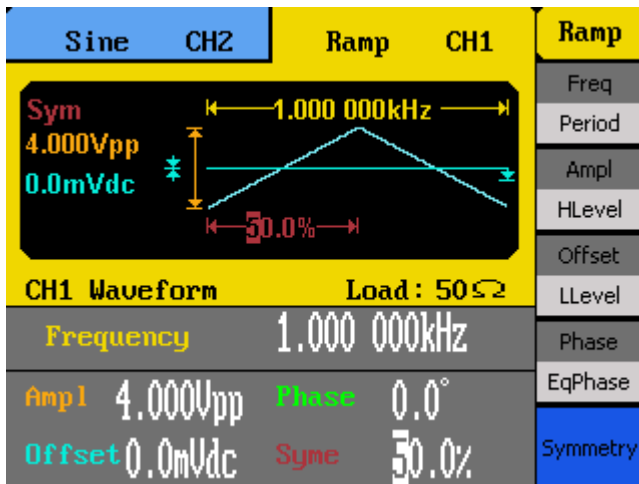

- Use the rotary knob or the numeric keypad to change the symmetry. If numeric keypad is used, the below screen will display:

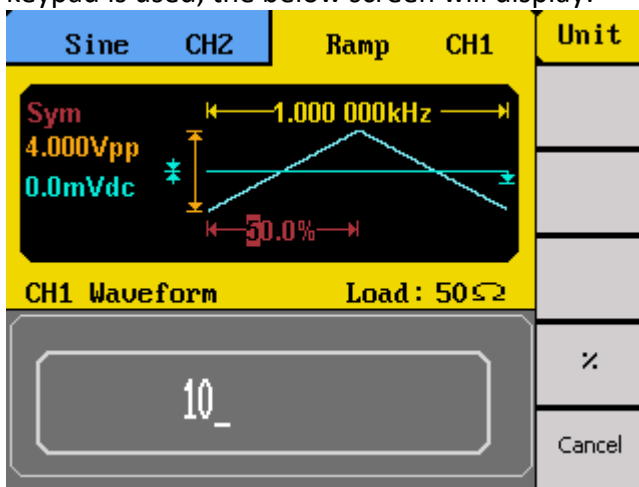

After entering the numeric value, use the menu function keys to select the percent (%) unit to apply for the symmetry setting.

Configure Pulse Waveform

Note: This section applies to pulse waveform only.

Pulse Width and Pulse Duty Cycle

The pulse width and duty cycle parameters are related and both control the length of the high level of the pulse. Users have the option to specify the pulse width in units of seconds or specify duty cycle as a percentage.

Note: The instrument allows for adjusting pulse width at a minimum of 1 ns, however its actual minimum resolution is 8 ns. Therefore, the pulse width change can be observed in increments of 8 ns.

Follow the steps below to configure the pulse width or duty cycle.

1. Set the instrument for pulse output by pressing the **Pulse** button.
2. From the menu, select **PulWidth** for pulse width adjustment or **Duty** for duty cycle adjustment.
3. The cursor position will now highlight the first digit of the width or duty parameter display.



4. Use the rotary knob or the numeric keypad to change the width or the duty. After entering the numeric value, use the menu function keys to select the **s**, **ms**, **us**, or **ns** for pulse width or select percent (%) unit for duty cycle.

Pulse Delay

Follow the steps below to configure the pulse delay.

1. Set the instrument for pulse output by pressing the **Pulse** button.
2. From the menu, select **Delay**.
3. The cursor position will now highlight the first digit of the delay parameter display.

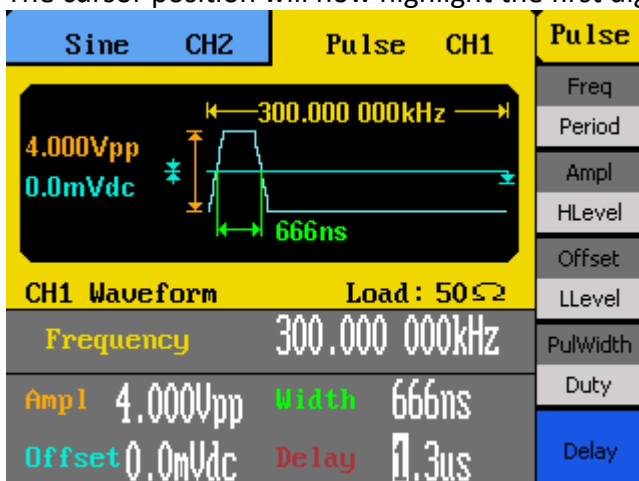

4. Use the rotary knob or the numeric keypad to change the pulse delay. After entering the numeric value, use the menu function keys to select the **s**, **ms**, **us**, or **ns**.

Configure Noise Waveform

Note: This section applies to noise waveforms only.

Standard Deviation and Mean

There are two parameters that can be adjusted of the noise waveform: Standard deviation, mean.

Follow the steps below to configure these parameters.

1. Set the instrument for noise output by pressing the **Noise** button.
2. From the menu, select **Stdev** for the standard deviation adjustment or **Mean** for the mean adjustment.
3. The cursor position will now highlight the first digit of the standard deviation or mean parameter display.

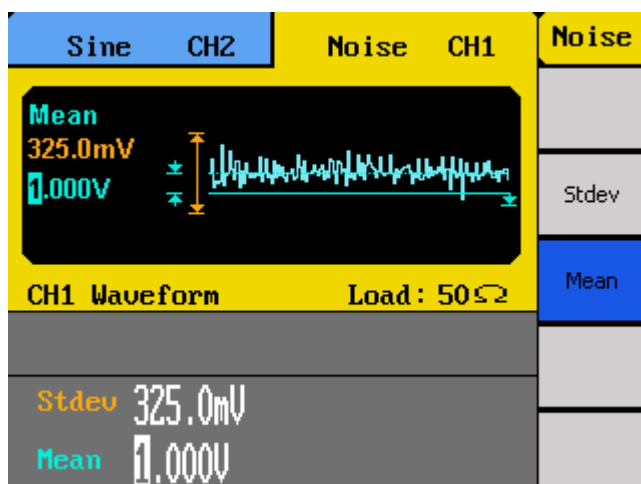
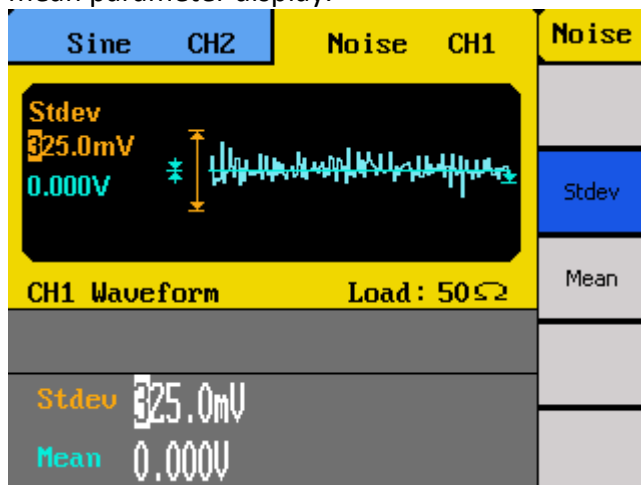

- Use the rotary knob or the numeric keypad to change the two parameters. Both parameters can be specified in **V** or **mV** units.

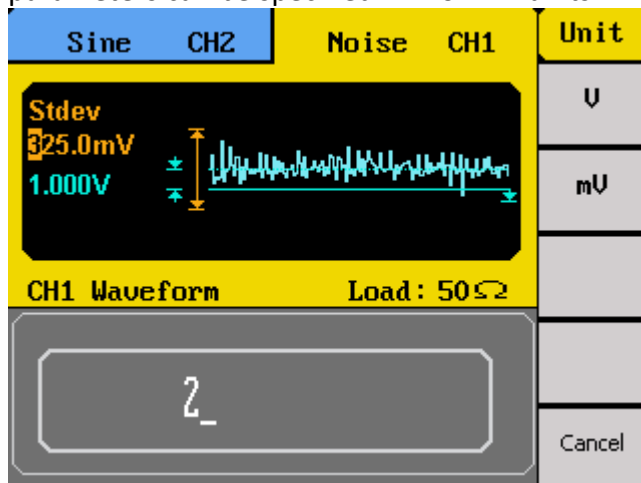

Configure Arbitrary Waveform

There are two ways to generate arbitrary waveforms. Users can output an arbitrary waveform selected from the built-in selection of pre-defined arbitrary waveforms, or create and output a user defined waveform by specifying point by point arbitrary data. This section will explain how to do both.

Generate Predefined Built-in Waveforms

There are a total of 48 (including sine, square, and ramp/triangle) predefined built-in arbitrary waveforms that can be output from the generator. They are divided into four categories: Common waveforms, math waveforms, special (project) waveforms, Windowing/trigonometric waveforms.

Note: PPulse and NPulse waveforms are limited to 4.999999 MHz.

Common Waveforms

StairUp	StairDn	StairUD	PPulse
NPulse	Trapezia	UpRamp	DnRamp

Command waveforms consist of:

StairUp	Upward staircase	StairDn	Downward staircase
StairUD	Down and up staircase	PPulse	Positive pulse
NPulse	Negative pulse	Trapezia	Trapezoidal

UpRamp	Upward ramp	DnRamp	Downward ramp
---------------	-------------	---------------	---------------

Math Waveforms

ExpFall	ExpRise	LogFall	LogRise
Sqrt	Root3	X^2	X^3
Sinc	Gaussian	Dlorentz	Haversin
Lorentz	Gauspuls	Gmonpuls	Tripuls

Math waveforms consist of:

ExpFall	Exponential fall	ExpRise	Exponential rise
LogFall	Logarithmic fall	LogRise	Logarithmic rise
Sqrt	Square root function	Root3	Root three ($\sqrt[3]{x}$) function
X^2	X ² function	X^3	X ³ function
Sinc	Sinc function	Gaussian	Gaussian function
Dlorentz	D-lorentz function	Haversine	Haversine function
Lorentz	Lorentz function	Gauspuls	Gaussian modulated sinusoidal pulse
Gmonpuls	Gaussian mono pulse	Tripuls	Triangle pulse

Special (project) Waveforms

Cardiac	Quake	Chirp	TwoTone
SNR			

Special (project) waveforms consist of:

Cardiac	Cardiac signal	Quake	Earthquake
Chirp	Frequency sweep cosine	TwoTone	Two tone signal
SNR	Sine with white noise		

Window and Trigonometric Waveforms

Hamming	Hanning	Kaiser	Blackman
Gaussian	Triangle	Haris	Bartlett
Tan	Cot	Sec	Csc
Asin	Acos	Atan	ACot

Window and trigonometric waveforms consist of:

Hamming	Hamming window	Hanning	Hanning window
Kaiser	Kaiser window	Blackman	Blackman window
Gaussian	Gaussian window	Triangle	Triangle window
Haris	Haris window	Bartlett	Bartlett window
Tan	Tangent function	Cot	Cotangent function
Sec	Secant function	Csc	Cosecant function
Asin	Inverse sine function	Acos	Inverse cosine function
Atan	Inverse tangent function	ACot	Inverse cotangent function

Follow the steps below to browse and select a predefined arbitrary waveform.

1. Press the **Arb** button to enter the arbitrary waveform function menu.
2. Select **1/2** from the menu to go to the second page, then select **Load Wform**.
3. Select **Built-In** and there will be a table on the waveform display area and four categories to select from the menu. Select **Common** to browse the common waveforms. Select **Math** to browse the math waveforms. Select **Project** to browse the special (project) waveforms. Select **Winfun\Triangle** to browse the window and trigonometric waveforms.
4. After making the selection, use the up, down, left, or right arrow keys to select the desired predefined waveform.

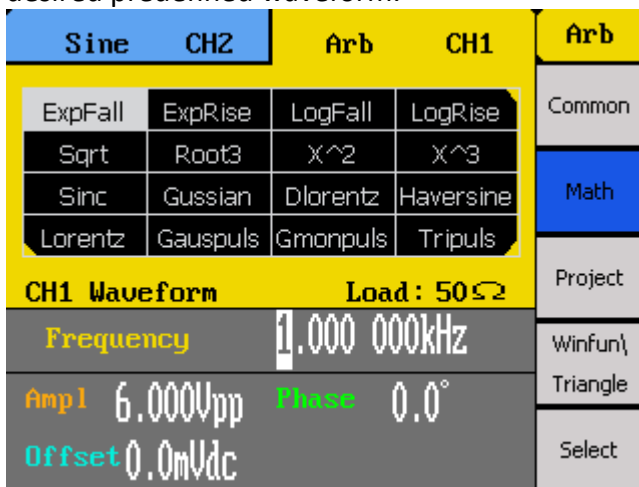

5. Once selected, press the **Select** option from the menu.
6. The generator will return to the main Arb menu and the waveform display area will show the waveform shape of the selected pre-defined arbitrary waveform. For example, below shows the display of the pre-defined **Cardiac** signal.

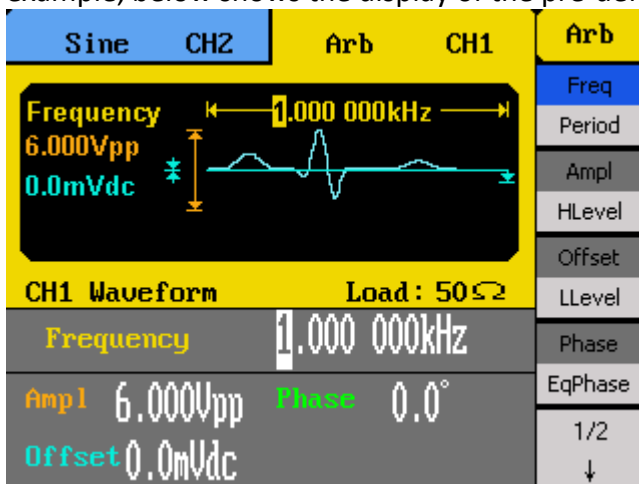

Generate User defined Waveforms

The generator has built-in non-volatile memory to store up to 10 user defined arbitrary waveforms, each with a maximum of 16k points.

To create an arbitrary waveform, users must use the USB interface in the rear panel for PC connectivity to the EasyWave software, which can be downloaded at www.bkprecision.com.

Note: EasyWave software supports Windows XP/Vista/7 (32 bit and 64 bit) only.

EasyWave software will allow users to easily create a custom arbitrary waveform and load it into the internal memory.

To select and output a saved arbitrary waveform from internal memory, follow the steps below.

1. Press the **Arb** button to enter the arbitrary waveform function menu.
2. Select **1/2** from the menu to go to the second page, then select **Load Wform**.
3. Select **Stored Wforms** and there will be a table on the waveform display area with the file names of all arbitrary waveforms that were created and loaded from EasyWave software.

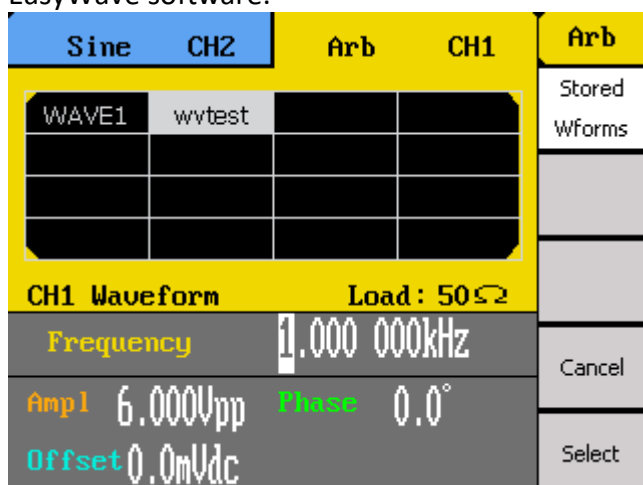

4. Use the up, down, left, or right arrow keys to select the arbitrary waveform to output from memory. Then, select the **Select** option from the menu to load the waveform. The instrument will return to the main arb menu.

Note: Arbitrary waveforms created in EasyWave software can also be saved into a .csv file to an external USB flash drive, which can also be transferred and stored into the internal non-volatile arbitrary waveform memory. See “3.7 Store and Recall” for details.

Configure DC Output

The instrument can output a DC waveform output at a few predefined voltage levels. See section “3.8 Utility Functions” for details.

3.4 Configure Modulation

The modulation functions can be accessed by pressing the **Mod** button from the front panel. The supported types of modulation are: **AM, DSB-AM, ASK, FM, FSK, PM.**

Note: Pulse, Noise, and DC waveforms cannot be modulated.

AM Modulation

Follow the steps below to setup AM modulation output.

1. Configure your waveform with the desired frequency and amplitude, then press the **Mod** button. Under **Type**, select **AM**.
2. There are four parameters that can be adjusted: **AM Freq, AM Depth, Shape,** and **Source.**

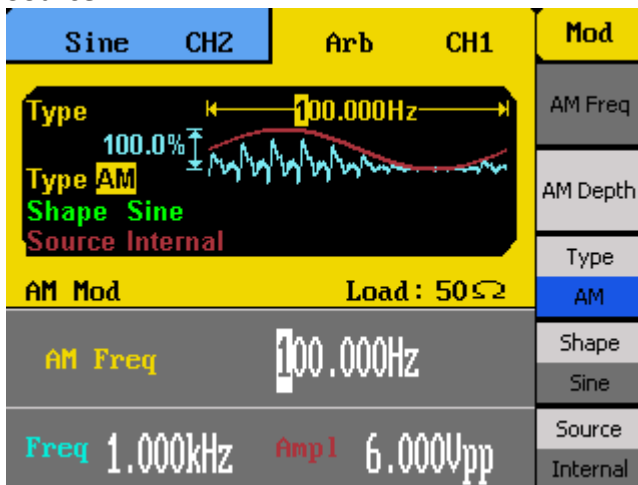

3. To adjust AM frequency, select **AM Freq** option from the menu. AM frequency parameter will be highlighted by the cursor on the first digit. Use the rotary knob or the numeric keypad to enter the modulating frequency.

AM Freq adjustable range: 2 mHz – 20 kHz

Note: Adjustable range is dependent on the carrier frequency.

4. Select **AM Depth** to adjust the depth of the amplitude modulation. Use the rotary knob or the numeric keypad to enter a depth percentage.

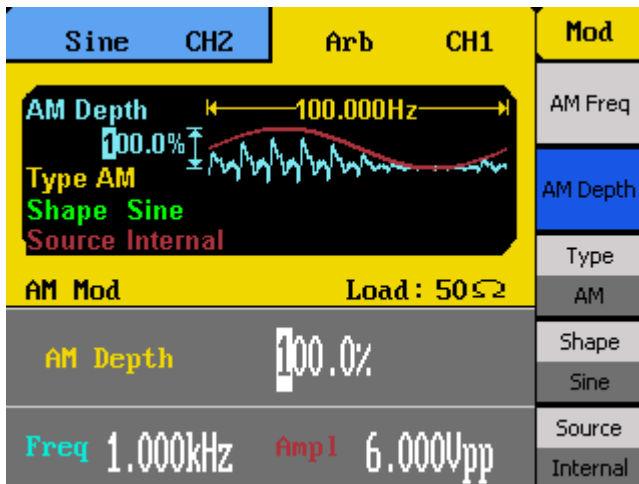

5. Select **Shape** to choose the shape of the modulating waveform. Options are: **Sine**, **Square**, **Triangle**, **UpRamp**, **DnRamp**, **Noise**, **Arb**.
UpRamp = Upward ramp waveform
DnRamp = Downward ramp waveform
Arb = This will be the waveform that is currently loaded from within the arb function menu. To change, follow the instructions in the previous section.
6. Select **Source** and choose between **Internal** or **External**.

Internal – The modulating source will be generated internally using the **AM Freq**, **AM Depth**, and **Shape** as defined in the previous steps.

External – Use external modulating source. Users can connect an external signal into the rear BNC terminal labeled **Modulation In** as the modulating source. **AM Freq**, **AM Depth**, and **Shape** options will not be available.

WARNING: Do not connect more than ± 6 V into the Modulation In terminal. This will damage the instrument and void its warranty.

DSB-AM

Follow the steps below to setup DSB-AM modulation output.

1. Configure your waveform with the desired frequency and amplitude, then press the **Mod** button. Under **Type**, select **DSB-AM**.
2. There are three parameters that can be adjusted: **DSB Freq**, **Shape**, and **Source**.

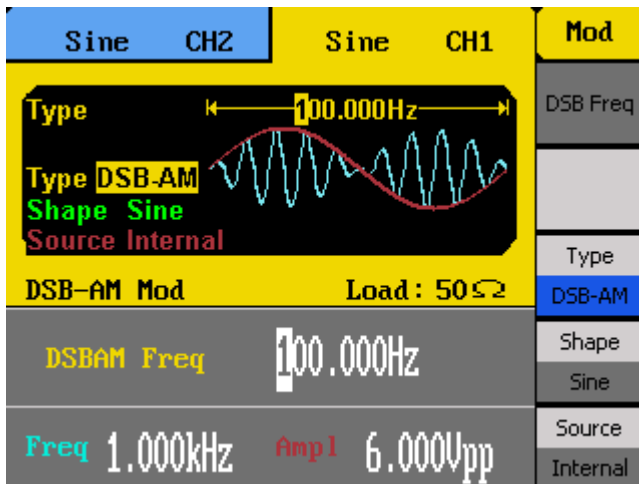

- To adjust DSB frequency, select **DSB Freq** option from the menu. DSB-AM frequency parameter will be highlighted by the cursor on the first digit. Use the rotary knob or the numeric keypad to enter the DSB modulating frequency.

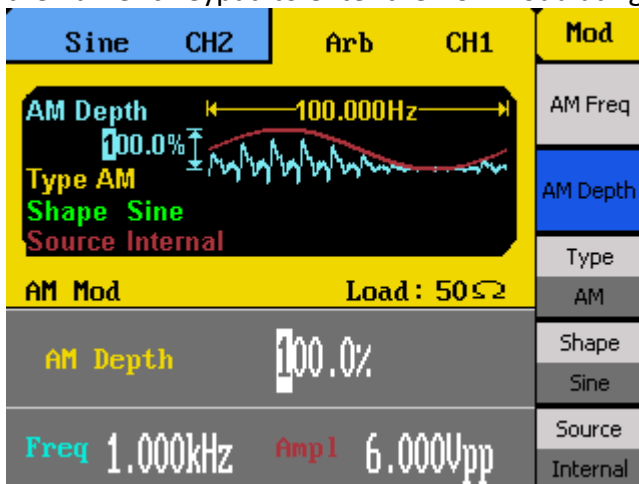

DSB Freq adjustable range: 2 mHz – 20 kHz

Note: Adjustable range is dependent on the carrier frequency.

- Select **Shape** to choose the shape of the modulating waveform. Options are: **Sine, Square, Triangle, UpRamp, DnRamp, Noise, Arb.**
UpRamp = Upward ramp waveform
DnRamp = Downward ramp waveform
Arb = This will be the waveform that is currently loaded from within the arb function menu. To change, follow the instructions in the previous section.
- Select **Source** and choose between **Internal** or **External**.

Internal – The modulating source will be generated internally using the **DSB Freq** and **Shape** as defined in the previous steps.

External – Use external modulating source. Users can connect an external signal into the rear BNC terminal labeled **Modulation In** as the modulating source. **DSB Freq**, and **Shape** options will not be available.

WARNING: Do not connect more than ± 6 V into the Modulation In terminal. This will damage the instrument and void its warranty.

ASK (Amplitude Shift Keying)

Follow the steps below to setup ASK modulation output.

1. Configure your waveform with the desired frequency and amplitude, then press the **Mod** button. Under **Type**, select **ASK**.
2. There are two parameters that can be adjusted: **Key Freq** and **Source**.

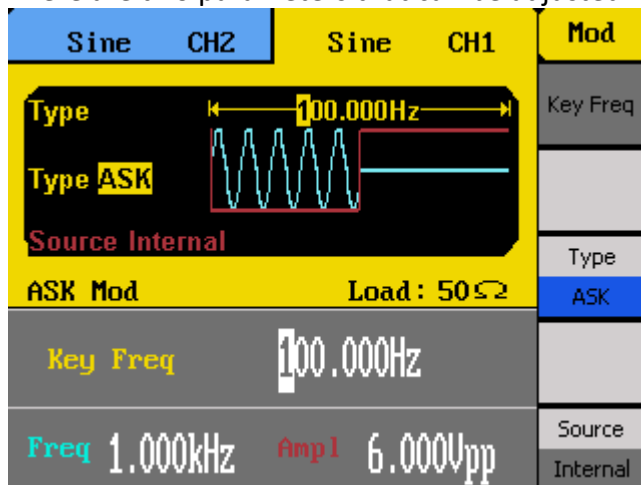

3. To adjust ASK frequency, select **Key Freq** option from the menu. Key frequency parameter will be highlighted by the cursor on the first digit. Use the rotary knob or the numeric keypad to enter the modulating frequency. This is the frequency at which the output amplitude shifts between the carrier amplitude and 0.
4. Select **Source** and choose between **Internal** or **External**.

Internal – The modulating source will be generated internally.

External – Use external modulating source. Users can connect an external signal into the rear BNC terminal labeled **ExtTrig/Gate/FSK/Burst** as the modulating source.

WARNING: Do not connect more than ± 6 V into the rear terminal. This will damage the instrument and void its warranty.

FM Modulation

Follow the steps below to setup FM modulation output.

1. Configure your waveform with the desired frequency and amplitude, then press the **Mod** button. Under **Type**, select **FM**.
2. There are four parameters that can be adjusted: **FM Freq**, **FM Dev**, **Shape**, and **Source**.

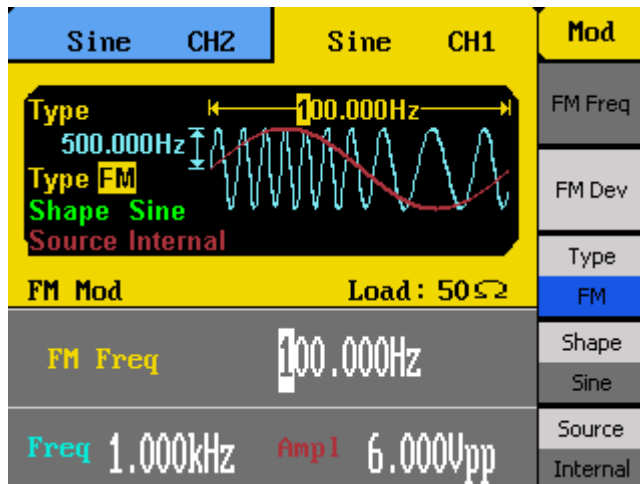

3. To adjust FM frequency, select **FM Freq** option from the menu. FM frequency parameter will be highlighted by the cursor on the first digit. Use the rotary knob or the numeric keypad to enter the modulating frequency.

FM Freq adjustable range: 2 mHz – 20 kHz

Note: Adjustable range is dependent on the carrier frequency.

4. Select **FM Dev** to adjust the Load maximum FM deviation. Use the rotary knob or the numeric keypad to enter the frequency.

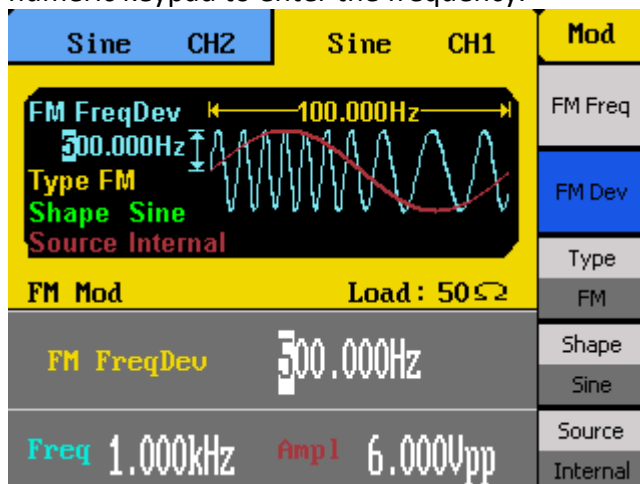

5. Select **Shape** to choose the shape of the modulating waveform. Options are: **Sine**, **Square**, **Triangle**, **UpRamp**, **DnRamp**, **Noise**, **Arb**.

UpRamp = Upward ramp waveform

DnRamp = Downward ramp waveform

Arb = This will be the waveform that is currently loaded from within the arb function menu. To change, follow the instructions in the previous section.

6. Select **Source** and choose between **Internal** or **External**.

Internal – The modulating source will be generated internally using the **FM Freq**, **FM Dev**, and **Shape** as defined in the previous steps.

External – Use external modulating source. Users can connect an external signal into the rear BNC terminal labeled **Modulation In** as the modulating source. **FM Freq** and **Shape** options will not be available.

WARNING: Do not connect more than ± 6 V into the Modulation In terminal. This will damage the instrument and void its warranty.

FSK (Frequency Shift Keying)

Follow the steps below to setup FSK modulation output.

1. Configure your waveform with the desired frequency and amplitude, then press the **Mod** button. Under **Type**, select **FSK**.
2. There are three parameters that can be adjusted: **Key Freq**, **Hop Freq**, and **Source**.



3. To adjust FSK frequency, select **Key Freq** option from the menu. Key frequency parameter will be highlighted by the cursor on the first digit. Use the rotary knob or the numeric keypad to enter the modulating frequency. This is the frequency at which the output frequency shifts between the carrier frequency and the hop frequency.
4. Select **Hop Freq** to adjust the hop frequency.
5. Select **Source** and choose between **Internal** or **External**.

Internal – The modulating source will be generated internally.

External – Use external modulating source. Users can connect an external signal into the rear BNC terminal labeled **ExtTrig/Gate/FSK/Burst** as the modulating source.

WARNING: Do not connect more than ± 6 V into the rear terminal. This will damage the instrument and void its warranty.

PM Modulation

Follow the steps below to setup phase modulation output.

1. Configure your waveform with the desired frequency and amplitude, then press the **Mod** button. Under **Type**, select **PM**.
2. There are four parameters that can be adjusted: **PM Freq**, **Phase Dev**, **Shape**, and **Source**.

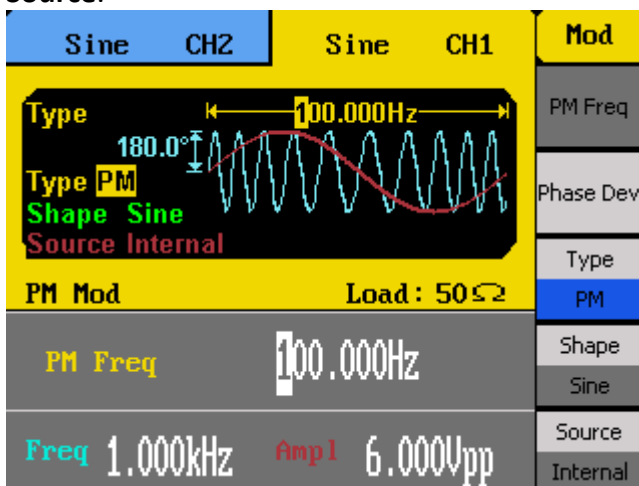

3. To adjust PM frequency, select **PM Freq** option from the menu. PM frequency parameter will be highlighted by the cursor on the first digit. Use the rotary knob or the numeric keypad to enter the modulating frequency.

PM Freq adjustable range: 2 mHz – 20 kHz

Note: Adjustable range is dependent on the carrier frequency.

4. Select **Phase Dev** to adjust the phase deviation. Use the rotary knob or the numeric keypad to enter the frequency.

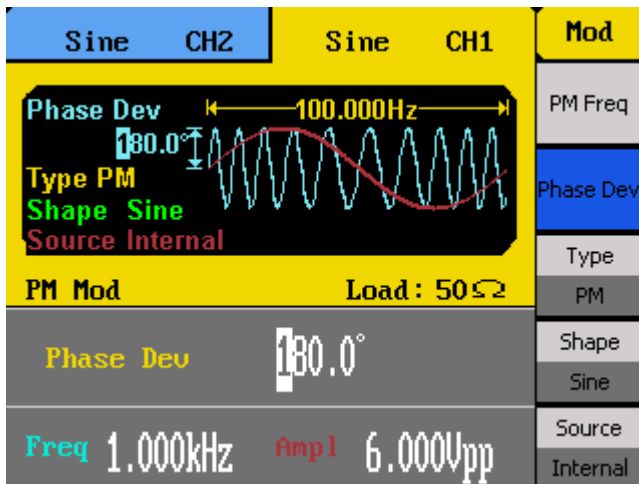

PM Deviation adjustable range: 0 ° – 360 °

5. Select **Shape** to choose the shape of the modulating waveform. Options are: **Sine, Square, Triangle, UpRamp, DnRamp, Noise, Arb.**
UpRamp = Upward ramp waveform
DnRamp = Downward ramp waveform
Arb = This will be the waveform that is currently loaded from within the arb function menu. To change, follow the instructions in the previous section.
6. Select **Source** and choose between **Internal** or **External**.

Internal – The modulating source will be generated internally using the **PM Freq, Phase Dev, and Shape** as defined in the previous steps.

External – Use external modulating source. Users can connect an external signal into the rear BNC terminal labeled **ExtTrig/Gate/FSK/Burst** as the modulating source. **PM Freq** and **Shape** options will not be available.

WARNING: Do not connect more than ± 6 V into the rear terminal. This will damage the instrument and void its warranty.

PWM Modulation

Follow the steps below to setup pulse modulation output.

1. Press the **Pulse** button to select pulse waveform. Then configure your waveform with the desired frequency and amplitude, then press the **Mod** button.
2. There are four parameters that can be adjusted: **PWM Freq, Width Dev, Shape, and Source.**

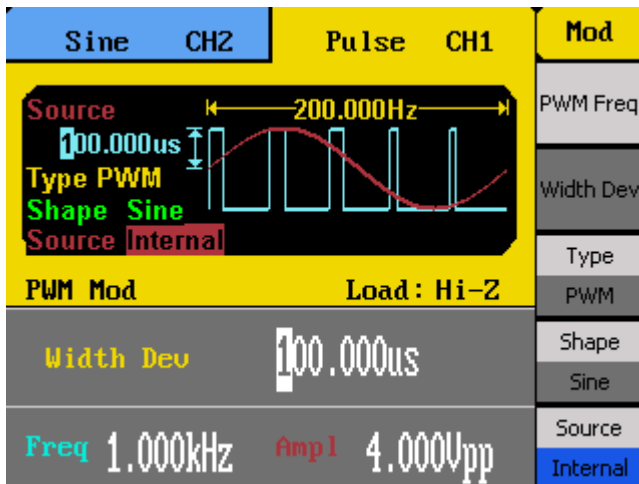

- To adjust PWM frequency, select **PWM Freq** option from the menu. PWM frequency parameter will be highlighted by the cursor on the first digit. Use the rotary knob or the numeric keypad to enter the modulating frequency.

PWM Freq adjustable range: 2 mHz – 20 kHz

Note: Adjustable range is dependent on the carrier frequency.

- Select **Width Dev** to adjust the pulse width deviation. Use the rotary knob or the numeric keypad to enter the frequency.

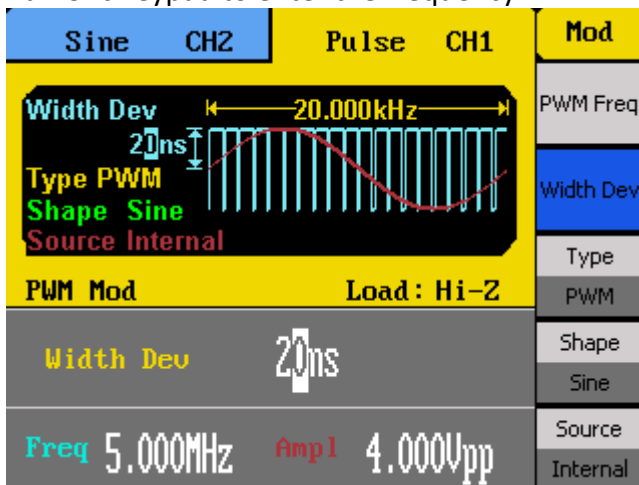

Note: Width deviation adjustable range is dependent on the carrier frequency.

- Select **Shape** to choose the shape of the modulating waveform. Options are: **Sine, Square, Triangle, UpRamp, DnRamp, Noise, Arb.**
UpRamp = Upward ramp waveform
DnRamp = Downward ramp waveform
Arb = This will be the waveform that is currently loaded from within the arb function menu. To change, follow the instructions in the previous section.
- Select **Source** and choose between **Internal** or **External**.

Internal – The modulating source will be generated internally using the **PWM Freq**, **Width Dev**, and **Shape** as defined in the previous steps.

External – Use external modulating source. Users can connect an external signal into the rear BNC terminal labeled **Modulation In** as the modulating source. **PWM Freq** and **Shape** options will not be available.

WARNING: Do not connect more than ± 6 V into the rear terminal. This will damage the instrument and void its warranty.

3.5 Configure Sweep Output

Note: Sweep function is available for sine, square, ramp, and arbitrary waveforms. It is not available for pulse, noise, or DC waveforms.

Burst function cannot operate when in sweep mode.

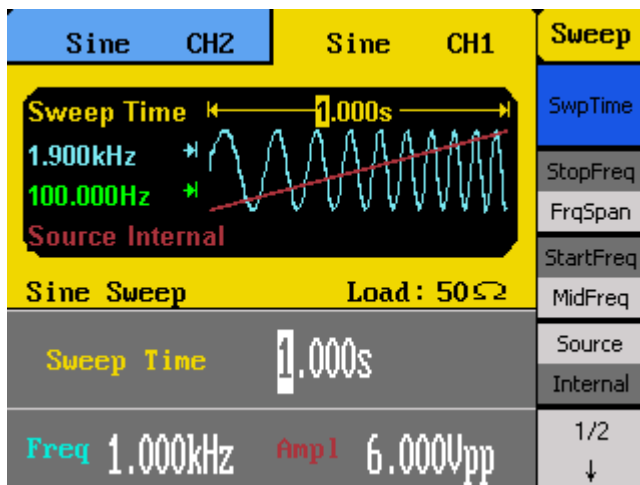

Follow the steps below to setup a sweep output from the generator.

1. Configure your waveform with the desired frequency and amplitude, then press the **Sweep** button.
2. There are many adjustable parameters to configure the sweep function: **SwpTime**, **StopFreq**, **FrqSpan**, **StartFreq**, **MidFreq**, **Source**, **Trig Out** (internal source), **Edge** (external source), **Linear/Log**, **Direction**, and **Trig** (manual source).
3. To set the sweep time/rate, select **SwpTime** from the menu and use the rotary knob or the numeric keypad to enter the sweep time in seconds.
Sweep time is the number of seconds required to sweep from the start to stop frequency. The generator will calculate the number of points required in the sweep based on this time.
4. To set the stop frequency, select **StopFreq** from the menu and use the rotary knob or the numeric keypad to enter the stop frequency in Hz.

- Stop Frequency** is the frequency to which the sweep ends.
- To set the frequency span, select **FrqSpan** from the menu and use the rotary knob or the numeric keypad to enter the frequency span.
Frequency Span provides added control to the direction of the sweep.
 - To set the start frequency, select **StartFreq** from the menu and use the rotary knob or the numeric keypad to enter the start frequency in Hz.
Start Frequency is the frequency to which the sweep begins.
 - To set the center frequency, select **MidFreq** from the menu and use the rotary knob or the numeric keypad to enter the center frequency in Hz.
Center Frequency is the frequency at the center of the sweep.
 - Select **Source** and choose between **Internal**, **External**, or **Manual**.

Internal – Internal trigger source.

External – External trigger source. Users can connect an external signal into the rear BNC terminal labeled **ExtTrig/Gate/FSK/Burst** to trigger the sweep.

Manual – Manual trigger source.

- Press the **1/2** option to go to the second page of the menu.
If **Internal** source is previously selected, the **Trig Out** option will be available.

On – A square waveform with 50% duty cycle will output from the **ExtTrig** BNC connector at the beginning of the sweep. The frequency corresponds to the sweep time.

Off – Trigger output be disabled

If **External** source is previously selected, the **Edge** option will be available, and the **Trig On** option will not be available.

↑ The up arrow means it will trigger off the rising edge of the external signal.

↓ The down arrow means it will trigger off the falling edge of the external signal.

If **Manual** source is previously selected, the **Trig** option in RED will be available. Each press of this option using the function key on the front panel will trigger a sweep. Trig Out option is not available for manual source.

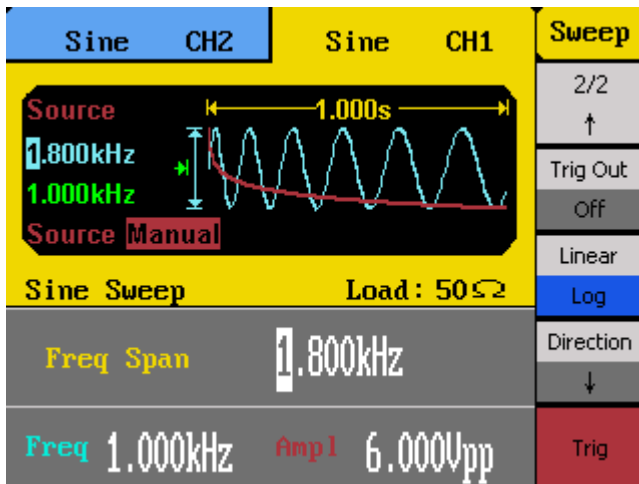

10. Use the function key to toggle selection between **Linear** or **Logarithmic** sweep. You can see which type is selected from the waveform display area.

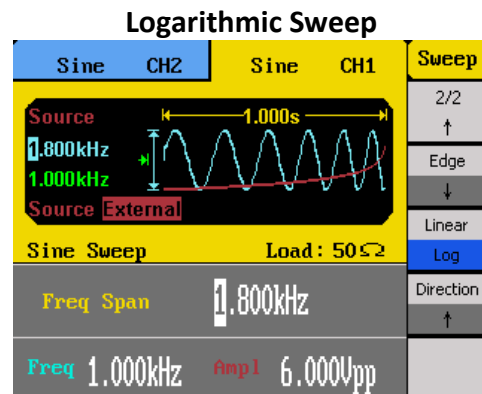
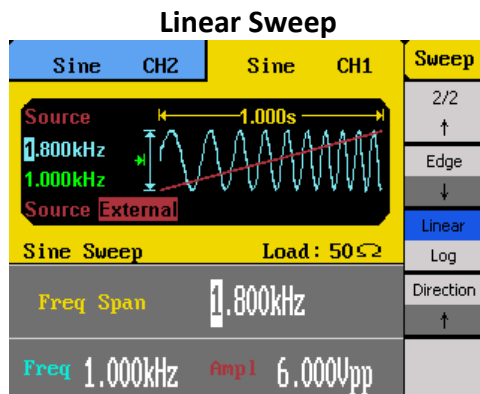

11. The direction of the sweep can be changed by toggling the function key corresponding to the **Direction** option.

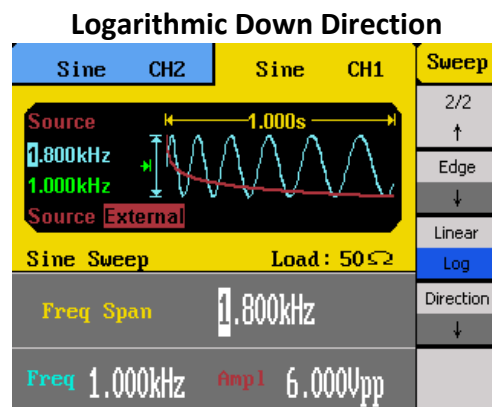
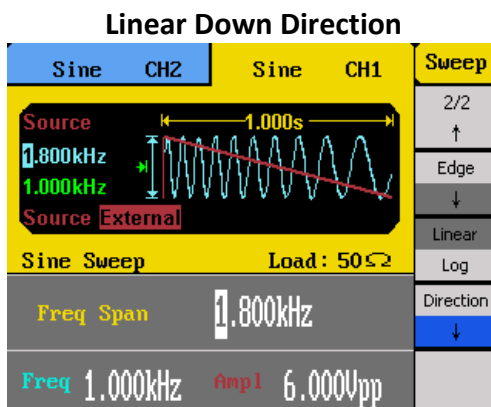

↑ The up arrow means the sweep will be in the normal direction (sweep up).

↓ The down arrow means the sweep will be in the reverse direction (sweep down).

3.6 Configure Burst

Note: Burst function is available for all waveforms, with the limitation on noise waveform in which only gated burst function is supported.

Sweep function cannot operate when in burst mode.

Gated burst operation is for use with an internal or external source only.

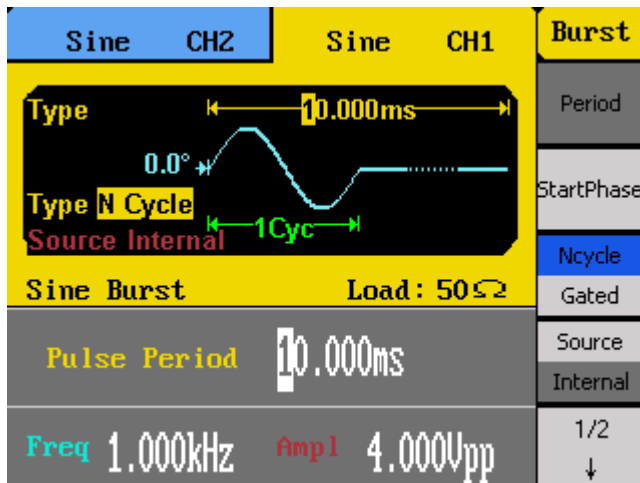

Follow the steps below to setup a burst output from the generator.

1. Configure your waveform with the desired frequency and amplitude, then press the **Burst** button.
2. There are many adjustable parameters to configure the sweep function: **Period**, **StartPhase**, **Ncycle**, **Gated**, **Source**, **Trig Out** (internal and manual source), **Edge** (external source), **Cycles/Infinite**, **Delay**, and **Trig** (manual source).
3. To set the burst period (rate), select **Period** from the menu and use the rotary knob or the numeric keypad to enter in seconds.
Burst Period/Rate is the frequency of the burst.
4. To set the start phase, select **StartPhase** from the menu and use the rotary knob or the numeric keypad to enter in degrees.
Start Phase is the phase of the waveform where the burst will begin.
5. There are two configurations that can be set for the burst function. One is to burst with control over the number of cycles. The other is gated burst. Toggle the menu function key to select **Ncycle** or **Gated** from the menu.

Ncycle – Use specified number of cycles of the waveform from the **Cycles** menu option to burst.

Gated – Use internal or external source to control the burst output. To use with internal source, select **Internal** for **source** and **Period** to adjust the burst period prior to selecting this option.

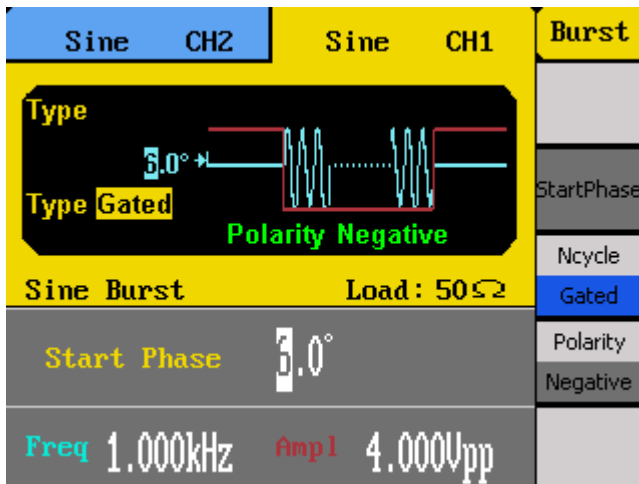

6. Select **Source** and choose between **Internal**, **External**, or **Manual**.

Internal – Internal trigger source. Burst will be controlled by the specified burst period.

External – External trigger source. Users can connect an external signal into the rear BNC terminal labeled **ExtTrig/Gate/FSK/Burst** to trigger the burst. This is for both **Ncycle** and **Gated** burst operations.

Manual – Manual trigger source.

7. If **Gated** option is selected, a **Polarity** option will be available. Toggle the corresponding menu function key to select between **Positive** or **Negative**.

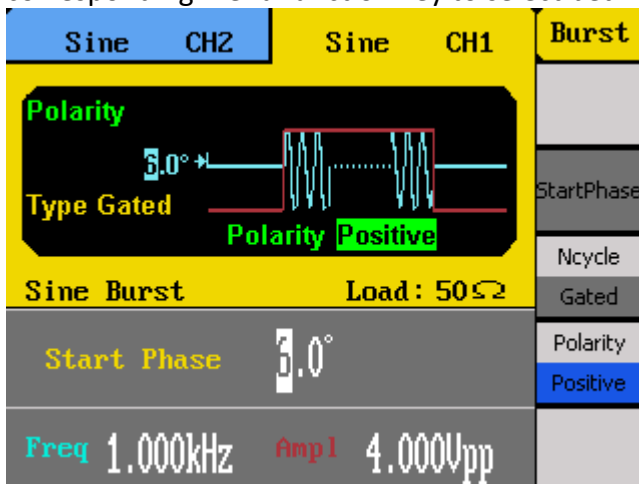

Positive – The positive polarity (High level) will cause the gated burst output.

Negative – The negative polarity (Low level) will cause the gated burst output.

8. Press the **1/2** option to go to the second page of the menu. If **Internal** source is selected previously, the **Trig On** option will be available.

On – A square waveform with 50% duty cycle will output from the **ExtTrig**

BNC connector at the beginning of the burst. The frequency corresponds to the burst period.

Off – Trigger output be disabled

If **External** source is selected previously, the **Edge** option will be available, and the **Trig On** option will not be available.



↑ The up arrow means it will trigger off the rising edge of the external signal.

↓ The down arrow means it will trigger off the falling edge of the external signal.

Note: These options are not available for Gated burst operations.

If **Manual** source is previously selected, the **Trig** option in RED will be available on the first page of the menu. Each press of this option using the function key on the front panel will trigger a burst. The **Trig On** option will also be available.

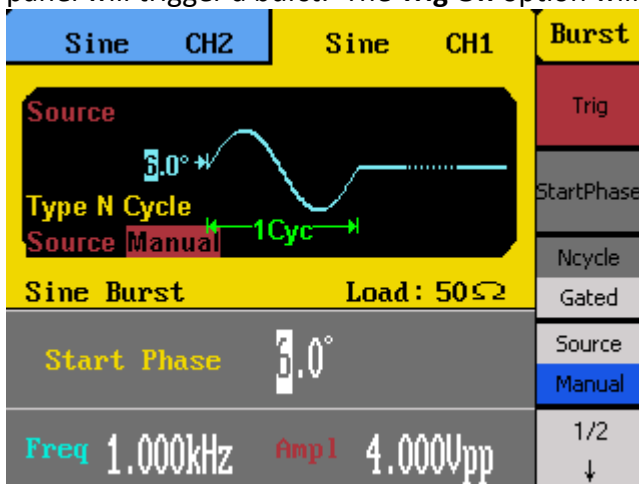

On – The **ExtTrig** BNC connector in the rear panel will output a pulse (>1 μHz) at the start of each sweep.

Off – The pulse output from the **ExtTrig** BNC connector is disabled.

9. If **Ncycle** is selected in the previous steps, the **Cycles/Infinite** option will be available. Use the corresponding menu function key to toggle between the two options. If **Cycles** is selected, use the rotary knob or the numeric keypad to enter the number of cycles to burst.

Cycles – Select to specify the number of cycles of the waveform to burst.
Adjustable range is 1 – 50,000 cycles

Infinite – Select to burst an infinite number of cycles of the waveform. This will create a continuous waveform which will not be stopped until a trigger even happens.

Note: For Infinite cycle, external or manual trigger is required to trigger the burst.

10. If **Ncycle** is selected in the previous steps, the **Delay** option will be available. Select it and use the rotary knob or the numeric keypad to adjust the burst delay.

Maximum delay is 240 ns.

Note: If required, the burst period will increase to accommodate the specified number of cycles. If Infinite cycle is selected, external or manual source is required to trigger the burst output. The default is external source.

3.7 Store and Recall

The instrument can easily store or recall instrument settings and arbitrary waveforms from internal memory or an external USB flash drive.

Note: If a USB flash drive is connected to the front port, wait two seconds (time required to read the flash drive information) after pressing the **Store/Recall button for the file browser screen to load up.**

Accessing Store/Recall Menu

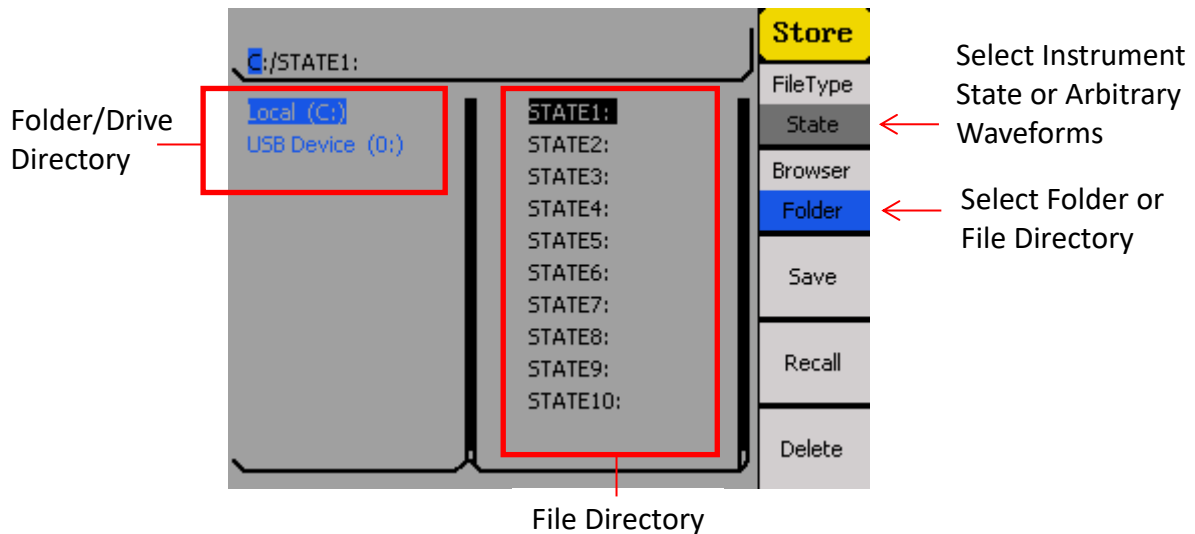

To access the store and recall menu, press the **Store/Recall** button from the front panel. The above screen will display.

The left column is the folder or drive directory. Internal storage is labeled as **Local (C:)**. If an external USB flash drive is connected, **USB Device (0:)** will show in the directory.

The right column is the file directory, which lists all the internal storage locations for instrument state as well as arbitrary waveforms. If external USB flash drive is selected from the folder/drive directory, the file directory will show the root folder of the USB flash drive.

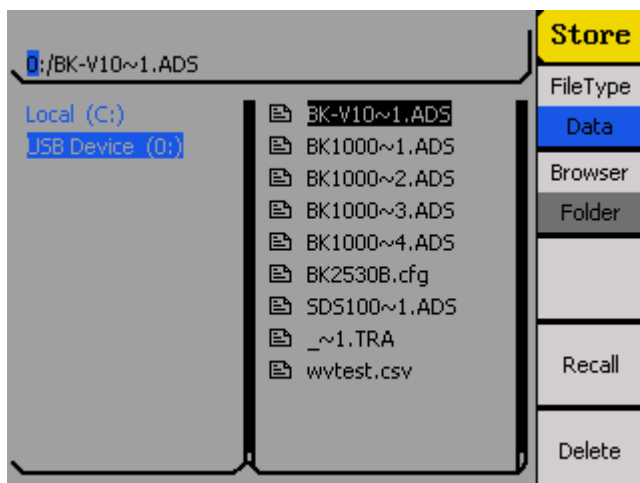

Press the corresponding menu function key to select between **Folder** or **File** under **Browser**. This will select either the folder or drive directory (left column) or the file directory (right column). The selected column will have the selection cursor in blue.

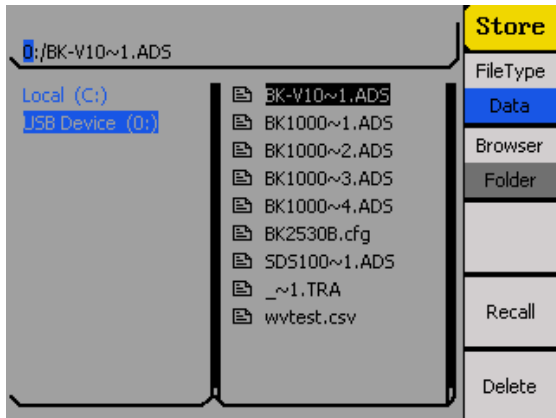

Browse Folder Directory

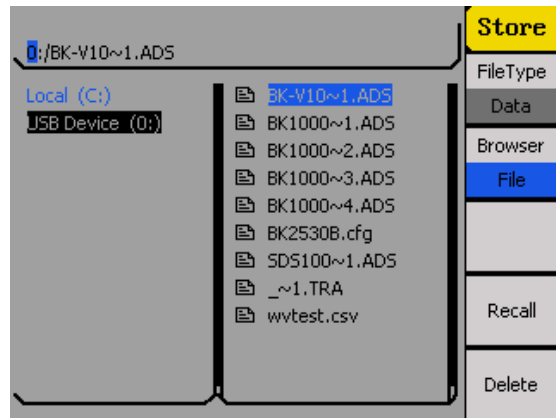

Browse Files Directory

Press the corresponding menu function key to select between **State** or **Data** under **FileType**. Select **State** to show the list of internal instrument states. Select **Data** to show the list of internal arbitrary waveforms.

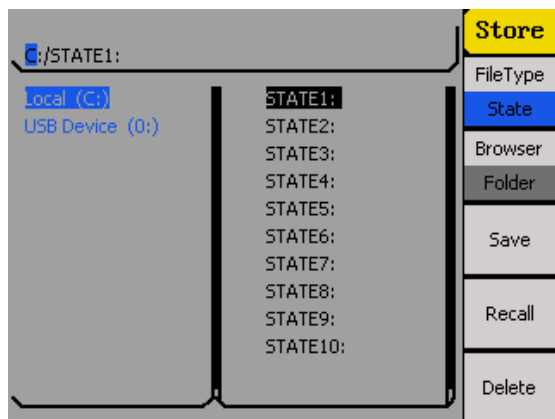

Instrument States List

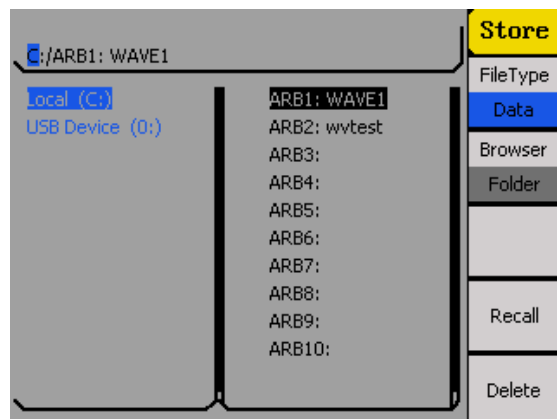

Arbitrary Waveforms List

Use the up or down arrow keys to move the selection cursor between the lists.

Store and Recall Instrument State

Follow the instructions in this section to store and instrument state to internal or external memory.

Store to and Recall from Internal Memory

1. Configure the instrument with all the settings that you want to save, then press the **Store/Recall** button.
2. From the **Store/Recall** menu, select **Folder** under **Browser** and select **Local (C:)**.

3. Press the menu function key corresponding to **Browser** again to change to **File**.
4. From the menu, change **FileType** to **State**.
5. Use the up and down arrow keys to move the selection cursor and highlight any item (state memory locations) on the list from **STATE1 – STATE 10**.
6. Once selected, press the **Save** option from the menu to store current instrument settings into the selected state memory location.
7. The screen will ask you to enter a file name. Use the rotary knob to change the highlighted selection from the on-screen keyboard to select each character for the file name. Once selected, press **Select** option from the menu to enter the highlighted character. To delete characters, press **Delete** from the menu. To cancel, press **Cancel** from the menu.

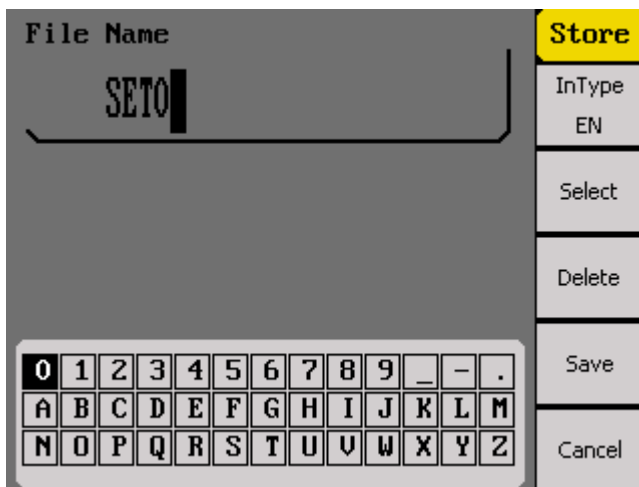

8. When finished, select **Save** from the menu. If saved successfully, a “**Store state success!**” message will be shown. Wait a few seconds before the screen returns to the **Store/Recall** main display.
9. Now, the selected state memory location will have a file name next to the **STATE#:**.

To recall stored instrument states:

10. Select **File** under **Browser** from the menu and use the up and down arrow keys to select the state memory location.
11. From the menu, select **Recall** and the instrument settings saved at the selected location will load. If loaded successfully, a message will be shown “**Read finished, read state success!**”

Store to and Recall from External USB Drive

1. Configure the instrument with all the settings that you want to save, then press the **Store/Recall** button.
2. From the **Store/Recall** menu, select **Folder** under **Browser** and select **USB Device (0:)**.
3. From the menu, change **FileType** to **State**.
4. Press the **Save** option from the menu.
5. The screen will ask you to enter a file name. Use the rotary knob to change the highlighted selection from the on-screen keyboard to select each character for the

file name. Once selected, press **Select** option from the menu to enter the highlighted character. To delete characters, press **Delete** from the menu. To cancel, press **Cancel** from the menu.

6. When finished, select **Save** from the menu. If saved successfully, a “**Store state success!**” message will be shown. Wait a few seconds before the screen returns to the **Store/Recall** main display.
7. The file directory displaying the contents of the USB flash drive will now have a new file with the entered filename with a **.SET** extension. This is the file type used to store instrument states.

To recall stored instrument states, select the **USB Device (0:)** from the folder directory, then use the up and down arrow keys to highlight the saved **.SET** file and select **Recall** from the menu.

Store and Recall Arbitrary Waveforms

Follow the instructions in this section to store and recall arbitrary waveforms to internal or external memory.

Store Arbitrary Waveforms

Note: To store arbitrary waveforms into internal memory or external USB flash drive requires the use of EasyWave software. The software will have an option to load the waveforms into the generator, which will then be stored into the internal memory. Waveforms created in EasyWave can also be saved into a **.csv** file onto a USB flash drive, which can be loaded into the generator’s arbitrary waveform memory.

Recall Arbitrary Waveforms

Follow the steps below to recall internally saved arbitrary waveforms.

1. From the **Store/Recall** menu, select **Folder** under **Browser** and select **Local (C:)**.
2. From the menu, change **FileType** to **Data**. Then, change **Browser** to **File**.
3. The list of arbitrary waveform memory locations are listed here as **ARB1 – ARB10**.
4. The file name used to load from EasyWave will be listed here if it was transferred successfully.
5. Use the up and down arrow keys to move the selection cursor and select the location with the arbitrary waveform you want to output.
6. Press the **Recall** option, and the instrument will automatically load the instrument into the arb menu with the selected waveform loaded and shown on display.

Follow the steps below to recall arbitrary waveforms stored in an external USB flash drive.

1. Connect the USB flash drive to the front panel USB port, and a message will appear on the display after a second “**A USB drive has been detected.**”
2. Press the **Store/Recall** button and select **Folder** under **Browser** and select **USB Device (0:)**.
3. From the menu, change **FileType** to **Data**. Then, change **Browser** to **File**.
4. Use the up and down arrow keys to move the selection cursor and select the .csv file from the USB flash drive that contains the arbitrary waveform data saved from EasyWave software.
5. Select the **Recall** option from the menu and wait for a few seconds for the instrument to load the data file. Once finished, a message will appear “**Your data has been read. Please choose a memory location.**”

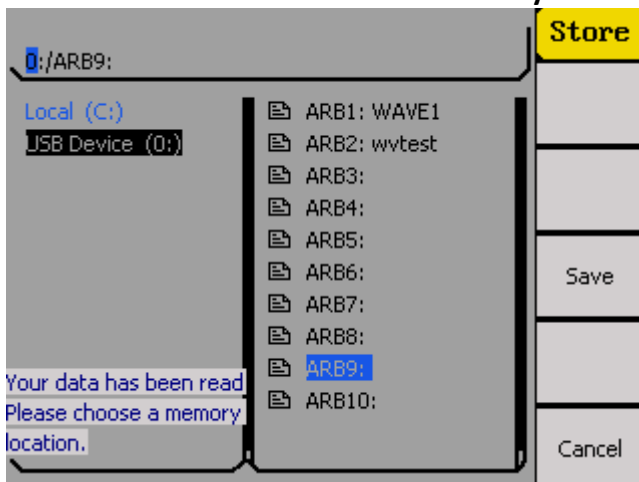

6. Use the up and down arrow keys again to move the selection cursor and select any of the arbitrary waveform memory locations listed (**ARB1 – ARB10**).

Note: The instrument can only load arbitrary waveforms that are stored into the internal memory, so waveforms that are saved onto an external USB flash drive must be loaded back the internal memory.

7. Select **Save** from the menu to transfer the loaded arbitrary waveform data from the external USB flash drive into the selected internal arbitrary waveform memory location.
8. The instrument will then automatically go into the arb menu with the selected waveform loaded and shown on display.

Note: If you browse through the internal arbitrary waveform memory locations, you will see the filename that was loaded from the USB flash drive now indicated next to the selected memory location.

3.8 Utility Functions

The utility menu can be accessed by pressing the **Utility** button from the front panel. This section describes all the settings configurable under this menu.



DC Waveform Output

The instrument can output a DC waveform by turning the **DC** menu option to **On**. There are six available pre-defined DC offset output levels that can be selected from the menu: **1 V, -1 V, 2 V, -2 V, 5 V, -5 V**. Use the menu function keys to select any of these DC offset voltages.

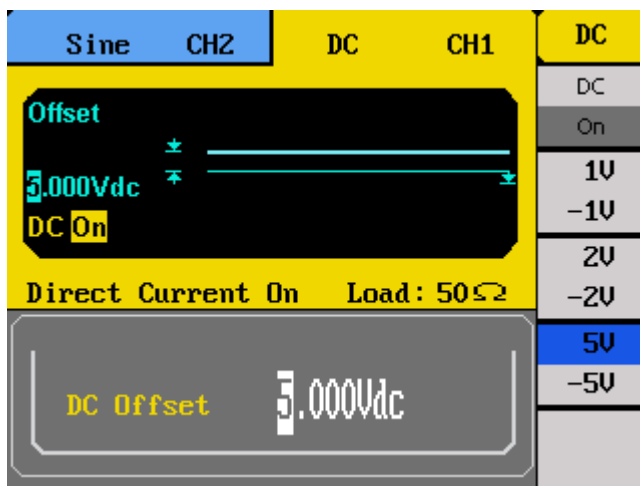

Remote Interface

The instrument has a USB interface in the rear panel for remote communication with EasyWave software. From the utility menu, press **Interface** to select the interface. Press **USB Setup** and select **USBTMC**, then select **Done**.



Note: USBRAW is reserved for factory use only.

A type A to type B USB cable is required for PC connectivity.

To connect with EasyWave software, you must install the USB driver. For Windows® 7 users, this may install automatically. For other users, visit www.bkprecision.com to download the driver.

Note: Users who have LabVIEW™ or NI-VISA installed will automatically have this driver in their system. In this case, driver download is not required.

GPIB Interface

The generator can be remotely controlled via GPIB using the optional **AK40G USB-to-GPIB adapter**.

Note: Be sure all devices are powered off before connecting the adapter to the USB port of the generator and/or the GPIB port on your computer.

Connecting AK40G

1. Connect the USB end of the AK40G to the front USB host port of the instrument. Since this port is a shared port, an external USB flash drive cannot be used during GPIB operation.
2. Connect the GPIB end of the AK40G to the computer via a GPIB cable.

- On the AK40G adapter, a RED LED light indicates power to the adapter. A YELLOW LED light indicates communication is in process.

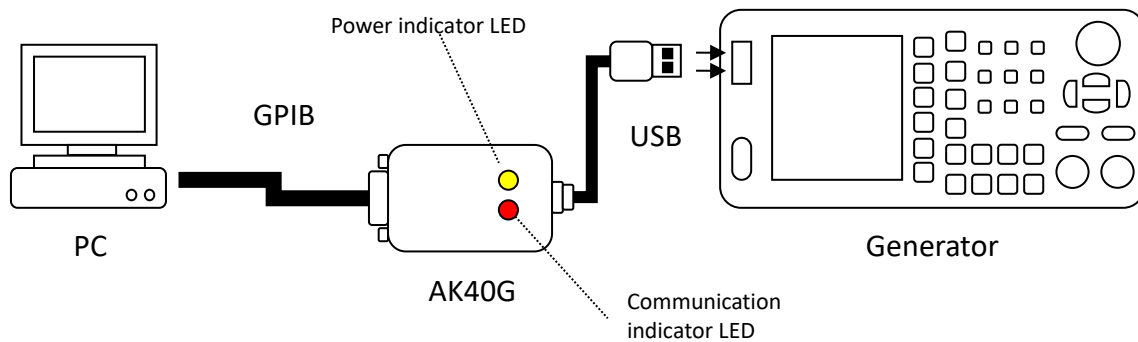

Figure 1 - Connecting AK40G GPIB adapter

Note: Once connected, do not unplug the adapter on either end, before powering down the instrument and the computer first.

Configure GPIB address

- Press **Utility** to enter the utility menu, and press **Interface** to select the interface.
- Press **GPIB** and use the rotary knob to set the GPIB address of the generator. The address range is 1 to 30.
- Be sure that **GPIB** is highlighted in blue to indicate GPIB as the selected interface for remote communication. Then, select **Done**.

Note: EasyWave software does not support GPIB interface. It must be used with USB interface only.

Note: All supported remote commands are described in the programming manual which can be downloaded from the B&K Precision website www.bkprecision.com.

Output Configurations

Select **Output Setups** from the utility menu to configure output parameters.

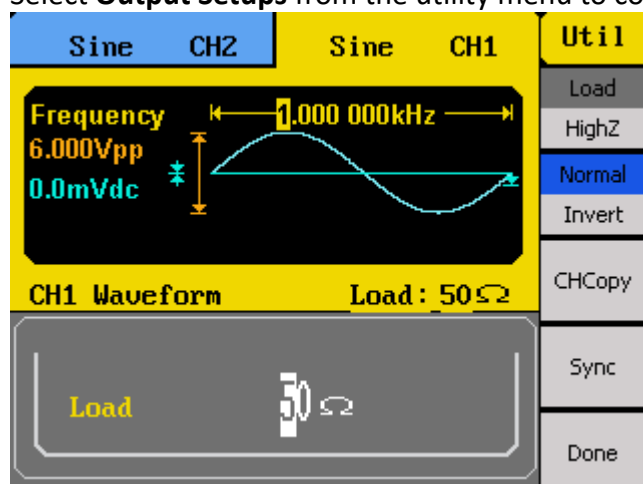

Output Impedance

The output impedance of the instrument can be switched between **50 Ω** and **HighZ** (high impedance). Select the menu function key corresponding to **Load** to toggle between the two settings.

Note: If you are connecting directly into an oscilloscope, note that most scopes have **1 M Ω** impedance. In this case, it is best to set the output impedance to **HighZ** to match the load impedance. However if your load impedance is **50 Ω** , keep output impedance set to **50 Ω** to match.

Invert Waveform

The main waveform can be inverted by simply selecting **Invert** from the utility menu. The corresponding menu function key can be pressed to toggle between **Normal** and **Invert** output. Inverting a waveform will not change the offset.

Duplicate Channel Parameters

The utility menu has an option that can allow quick copying between channel parameters. First, press **CHCopy** option from the menu, and the below menu will display.

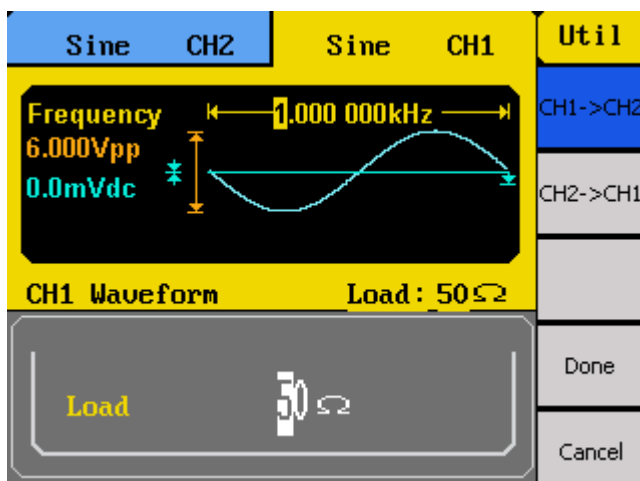

Select **CH1 -> CH2** to copy channel 1's parameter settings into channel 2. Likewise, select **CH2 -> CH1** to copy channel 2's parameter settings into channel 1. After selection, press **Done**, and now both channels are identical with the same parameter settings.

To cancel, select **Cancel**.

Sync Output

Note: Sync output is not available for noise and DC waveforms.

The rear panel has a **Sync Out** BNC terminal available to provide a synchronization output signal. This output can be enabled and can be setup to provide a sync signal that correlates with channel 1 or channel 2.

To set up, press the **Sync** option from the utility menu.

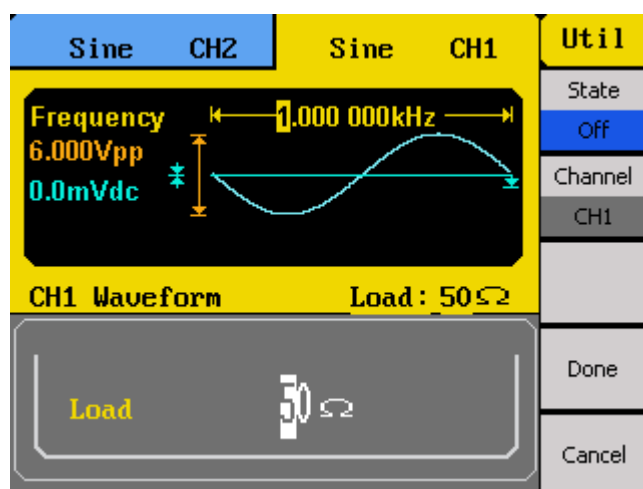

Under **Channel**, use the corresponding menu function key to select **CH1** or **CH2**. This will select the channel the output signal will be synchronized with.

To enable the sync output, select **On** for the **State** option.

To disable the sync output, select **Off** for the **State** option.

When finished, select **Done**. To cancel, select **Cancel**.

Note:

- **When waveform is Inverted, the corresponding sync signal does not invert.**
 - **For non-modulated waveform, the sync output reference is the carrier.**
 - **For internal modulating AM, FM, and PM, the sync output reference is the modulated signal (not the carrier).**
 - **For ASK and FSK, the sync output reference is the keying frequency.**
 - **When sweep is enabled, the sync output becomes TTL level high at the start of the sweep, and the sync frequency will be the same as the specified sweep time.**
 - **When burst is enabled, the sync output will be TTL level high at the start of the burst.**
-

- For external gated burst, the sync output follows the external gated signal.

Frequency Counter

The instrument has a built-in frequency counter. The counter input shares the same BNC terminal as the channel 2 main output terminal, labeled **CNT**. To access and enable the counter function, select the **Counter** option from the utility menu.

Note: When the counter function is enabled, channel 2 will automatically be disabled and the same BNC terminal will become the counter's input terminal.

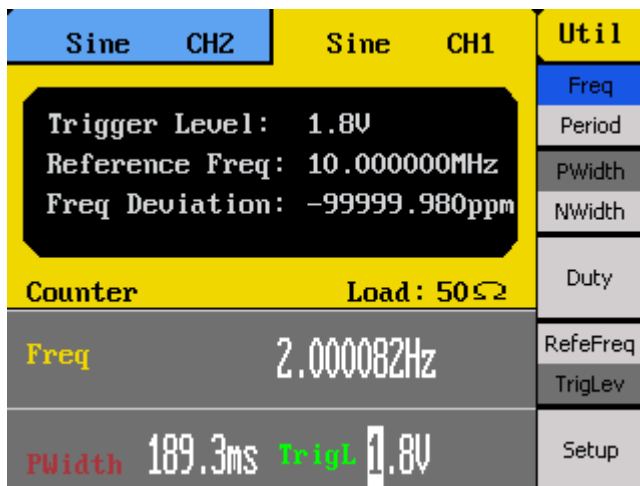

There are several measurement parameters that can be displayed when counter is enabled.

Measure Frequency/Period

The instrument can measure in frequency or period by selecting **Freq** or **Period** respectively from the counter menu.

Measure Width and Duty

The width of the signal can be measured. This parameter is especially useful for measuring square and pulse signals. Users can select between measuring positive or negative width by selecting **PWidth** or **NWidth** respectively from the counter menu. Users can also measure the duty cycle in percent of the signal by selecting **Duty** from the menu.

Adjust Reference Frequency

The default reference frequency used by the counter is 10 MHz. Users can change this reference frequency by selecting **RefeFreq** and use the rotary knob or the numeric keypad to change the reference frequency value.

Sine CH2	Sine CH1	Util
Trigger Level: 1.8V Reference Freq: 2.00000MHz Freq Deviation: -99999.899ppm		Freq
Counter Load: 50Ω		Period
Freq 2.000182Hz		PWidth
Duty 20.1% Refreq 2.0MHz		NWidth
		Duty
		RefeFreq
		TrigLev
		Setup

Adjust Trigger Level

The trigger level of the counter can be adjusted by selecting **TrigLev** from the menu. Use the rotary knob or the numeric keypad to change the trigger level. The maximum trigger level value is 1.8 V, and the minimum is – 3.0 V.

Counter Settings

There are some additional counter settings that can be adjusted, which may help improve the counter measurements of some signals.

To access these settings, select **Setup** from the counter menu, and an expanded set of menu options will be available.

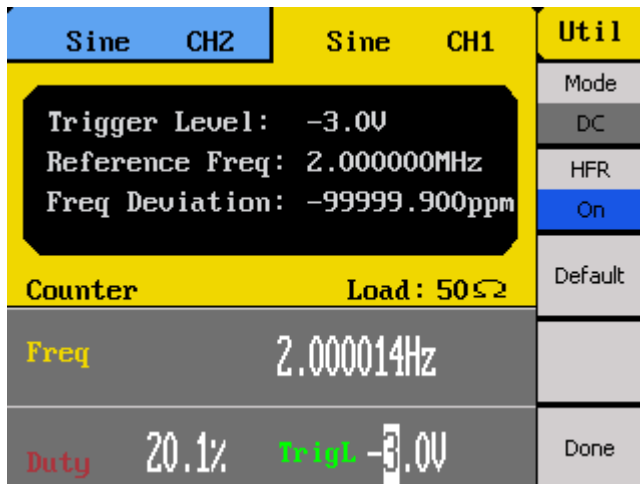

Coupling

The counter can be set to AC or DC coupling. Select **Mode** from the menu and toggle the corresponding menu function key to change between **DC** or **AC** for DC and AC coupling respectively.

HFR

A high frequency reject filter can be enabled or disabled. Enabling this filter may help improve the frequency measurements of certain signals. From the menu, select **HFR** and toggle the corresponding menu function key to turn it **On** or **Off**.

Default Settings

All of the counter settings can be configured to default values by selecting **Default** from the menu. Below is a table of the default settings.

Counter Parameters	Default Settings
Reference Frequency (RefeFreq)	10.000000 MHz
Trigger Level (TrigLev)	0.0 V
Coupling (Mode)	AC
High Frequency Reject Filter (HFR)	Off

Select **Done** to return to the counter main menu.

3.9 System Configurations

The second page of the utility menu contains system parameters that can be adjusted.



System Settings

In the utility menu, select **1/2** from the menu to go to the second page of the menu, then select the **System** option.



Numerical Format

The number format can be changed on the instrument. Select **Number Format** from the menu.

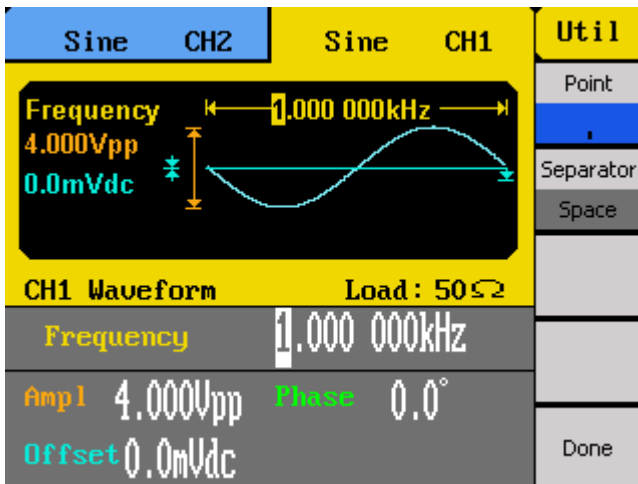

Toggle the corresponding menu function key to select **Point** to choose between using period (.) or comma (,) as the decimal representation of all numerical values on display.

Numeric separators can also be configured by selecting the **Separator** option. Choose between **On**, **Off**, or **Space**. Below illustrates the difference between the three on all applicable numerical values on the display.



Separator: Space

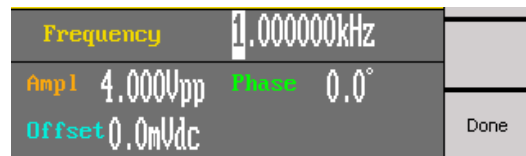

Separator: Off

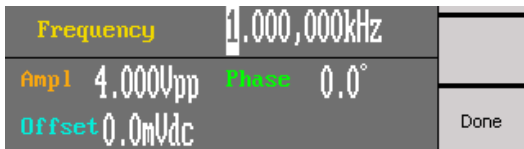

Separator: On

Select **Done** when finished.

Language

Default language is **English**. It can be changed to **simplified Chinese** by selecting the **Language** option from the second page of the utility menu. Press the corresponding menu function key to toggle between the two languages.

Power-On Settings

The power-on instrument settings can be configured to load the default values or values

configured during the last power-on state. This function can be used to retain instrument configurations in the case of power interruptions.

Press the **PowerOn** option from the menu to select between **Default** and **Last**.

Default will load default instrument settings during power up.

Last will load instrument settings from the last power up state.

Note: The output states of both channels cannot be recalled at power-on. For safety reasons, the states are disabled by default.

Set to Factory Default

You can set the instrument settings to factory default by selecting **Set to Default**. The instrument will change all settings to default, and the screen will return to the main display with Sine wave active.

Below is a table of the factory default settings:

Parameters	Default Settings
Function	Sine Wave
Frequency	1.000000 kHz
Amplitude	4 Vpp
Offset	0 V
Phase	0 °
Output Impedance	HighZ
Modulation	
Carrier Frequency	1.000000 kHz
Modulating Frequency	100 Hz
Modulation Shape	Sine Wave
AM Depth	100 %
FM Deviation	500 Hz
Key Frequency	100 Hz
FSK Hop Frequency	1 MHz
Phase Deviation	180 °
Sweep	
Start/Stop Frequency	100 Hz/1.9 kHz
Sweep Time	1 second
Trig Out	Off
Mode	Linear
Direction	↑
Burst	
Period	10.000 ms

Phase	0 °
Count	1 Cycle
Trig	Off
Source	Internal
Counter	
Measurement Mode	Frequency
Reference Frequency	10.000000 MHz
Trigger Level	0.0 V
Mode	AC
HFR	Off

Select **1/2** to go to the second page of the system menu.

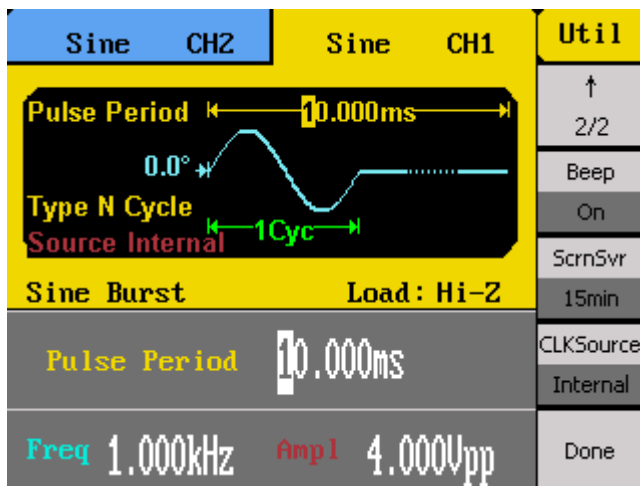

Key Sound

Select **Beep** and toggle the corresponding menu function key to turn the instrument key press sound **On** or **Off**. This will also disable the sound for any errors that may occur during front panel or remote operation.

Screen Saver

The instrument has a built-in screen saver function that automatically dims the display when left idle over a period of time specified by a timer. The timer can be changed by selecting the **ScrnSvr** option from the menu. Press the corresponding menu function key to change between: **1 min, 5 min, 15 min, 30 min, 1 hour, 2 hours, 5 hours, Off**.

Clock Source

By default, the instrument uses an internal clock source to generate output waveforms. An external 10 MHz clock source can also be used, especially for synchronization purposes. To change to use an external clock source, select **CLKSource** and set it to **External** by pressing the menu function key. To change it to **Internal**, press the key again.

When set to **External**, connect a 10 MHz reference signal to the rear BNC terminal labeled **10MHz In**.

Self Test and Adjustment

See section “2.3 Preliminary Check” under Output Check for details.

Check Instrument Information

Press **Utility** and press **1/2** to go to the second page of the utility menu. Select **EditInfo** to see information about the instrument. You will be able to find the following: **Boot up Times, Software version (firmware), Hardware version, Model, Serial Number**.

To exit, press any of the menu function keys or any of the waveform keys.

Updating Firmware

When updates are available, users can update the firmware of the instrument by following the below steps.

1. Go to www.bkprecision.com and download the firmware update file. The file format will have a **.ADS** extension.
2. Save the file onto a USB flash drive, then connect the drive into the front USB connector of the instrument.
3. Once the USB drive is detected, press **Utility** and press **1/2** to go to the second page of the utility menu.
4. Select **Update** option from the menu and the instrument will go into the **Store/Recall** main menu.
5. Select **Browser** and select **Folder**. Then use the rotary knob or the up and down arrow keys to select **USB Device (0:)**. Then select **Browser** again and change it to **File**.
6. On the right column, use the rotary knob or the up and down arrow keys to select the **.ADS** firmware file that was saved in the USB flash drive.
7. Then select **Recall** from the menu. Wait a few seconds and the firmware will begin updating the device.

8. When finished, a message will prompt you to restart the generator. At this point, power off the instrument and wait a few seconds, then power it back on.
9. The instrument will now have the updated firmware. You can verify this by checking the instrument information (follow instructions from the previous section to check).

3.10 Help System

A built-in help system is available to provide quick references on setting up common output configurations with the generator. To access the system, press the **Help** button from the front panel. The screen below will be displayed:

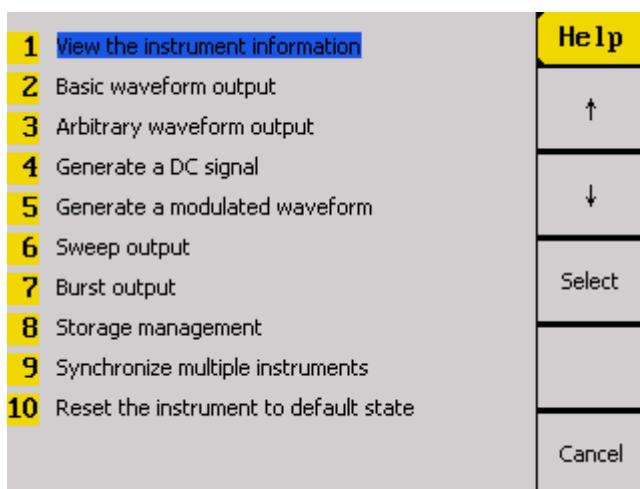

You can use the \uparrow \downarrow menu keys, the rotary knob, or the up and down buttons to select any of the ten items listed in the help system as shown above. Once selected (the cursor highlights the selection in blue), push the corresponding menu function key for the **Select** option and the screen will display a description of the selected help item.

When finished, press the **Cancel** option from the menu to go back to the main help menu.

4 Troubleshooting Guide

Below are some frequently asked questions and answers. Please check if any apply to your power supply before contacting B&K Precision.

Q: I cannot power up the generator

- Check that the power cord is securely connected to the AC input and there is live power from your electrical AC outlet.
- Verify that the AC power coming from the mains is the correct voltage. The generator can accept a specific range of AC input voltages. Refer to section "2.1".

Q: I cannot see any output out of the output terminals

- Make sure that the **Output** buttons above channel 1 and/or channel 2 is lit. If not, press it once. The backlight of these **Output** buttons indicates that the respective channel's output is enabled.

Q: I have connected my signal to an oscilloscope, but the amplitude is double of what I set

- This is often because the impedance of the generator is not matched with the oscilloscope. When the generator is set to 50 Ω impedance, connecting it directly to an oscilloscope with a 1 M Ω input impedance will cause this to happen. To eliminate this issue, connect a 50 Ω terminator to the input of the oscilloscope, then connect a BNC cable between the generator and the terminator to have matching impedance.

5 Specifications

Note: All specifications apply to the unit after a temperature stabilization time of 15 minutes over an ambient temperature range of $23\text{ }^{\circ}\text{C} \pm 5\text{ }^{\circ}\text{C}$. Specifications are subject to change without notice.

Environmental Conditions:

This instrument is designed for indoor use and operated with maximum relative humidity of 95%.

Model	4052	4053	4054	4055
Channels	2			
Frequency Characteristics				
Sine	1 μHz – 5 MHz	1 μHz – 10 MHz	1 μHz – 25 MHz	1 μHz – 50 MHz
Square	1 μHz – 5 MHz	1 μHz – 10 MHz	1 μHz – 25 MHz	
Triangle, Ramp	1 μHz – 300 kHz			
Pulse	500 μHz – 5 MHz			
Gaussian Noise (-3 dB)	> 5 MHz	> 10 MHz	> 25 MHz	> 50 MHz
Arbitrary	1 μHz – 5 MHz			
Accuracy	± 50 ppm (90 days) ± 100 ppm (1 year)			
Resolution	1 μHz			
Arbitrary Characteristics				
Built-in Waveforms	48 Built-in waveforms (includes DC)			
Waveform Length	16,000 points / Ch			
Vertical Resolution	14 bits			
Sampling Rate	125 MSa/s			
Minimum Rise/Fall Time	7 ns (typical)			
Jitter (pk-pk)	8 ns (typical)			
Non-volatile memory storage	10 waveforms			
Output Characteristics				
Amplitude Range	Channel 1: 2 mVpp – 10 Vpp into $50\ \Omega$, ≤ 10 MHz 2 mVpp – 5 Vpp into $50\ \Omega$, > 10 MHz 4 mVpp – 20 Vpp into open circuit, ≤ 10 MHz 4 mVpp – 10 Vpp into open circuit, > 10 MHz Channel 2: 2 mVpp – 3 Vpp into $50\ \Omega$ 4 mVpp – 6 Vpp into open circuit			
Amplitude Resolution	Up to 4 digits			
Amplitude Accuracy (100 kHz)	$\pm (0.3\ \text{dB} + 1\ \text{mVpp of setting value})$			
Amplitude Flatness (relative to 100 kHz, 5 Vpp)	$\pm 0.3\ \text{dB}$			

Cross Talk	< -70 dBc
Offset Range (DC)	Channel 1: ± 5 V into 50 Ω ± 10 V into open circuit Channel 2: ± 1.5 V into 50 Ω ± 3 V into open circuit
Offset Resolution	Up to 4 digits
Offset Accuracy	$\pm (\text{Offset setting value} * 1\% + 3 \text{ mV})$
Output Impedance	50 Ω (typical)
Output Protection	Short-circuit protection
Waveform Characteristics	
Harmonic Distortion	DC – 1 MHz, < - 60 dBc 1 MHz – 5 MHz, < -53 dBc 5 MHz – 25 MHz, < - 35 dBc 25 MHz – 50 MHz, < -32 dBc
Total Harmonic Distortion	DC – 20 kHz at 1 Vpp, < 0.2 %
Spurious (non-harmonic)	DC – 1 MHz, < -70 dBc 1 MHz – 10 MHz, < -70 dBc + 6 dB/spectrum phase
Phase Noise	10 kHz offset, - 108 dBc/Hz (typical)
Rise/Fall Time (Square)	< 12 ns (10 % - 90 %) at full amplitude into 50 Ω
Variable Duty Cycle (Square)	20% - 80% to 10 MHz 40% - 60% to 20 MHz 50% > 20 MHz
Asymmetry (50 % duty cycle)	1% of period + 20 ns (typical, 1 kHz, 1 Vp-p))
Jitter square)	0.1 % of period (typical, 1 kHz, 1 Vp-p)
Ramp Symmetry	0 % - 100 %
Linearity (Triangle, ramp at 1 kHz, 1 Vp-p, 100% symmetry)	< 0.1 % of peak output (typical)
Pulse	
Pulse Width	16 ns minimum, 8 ns resolution
Rise/Fall Time	7 ns (typical) at 1 kHz, 1 Vpp from 10 % – 90%
Duty Cycle	0.1 % resolution
Overshoot	< 5 %
Jitter (pk-pk)	8 ns
Burst	
Waveform	Sine, Square, Ramp, Pulse, Arbitrary (except DC)
Type	Cycle (1 – 50,000 cycles), Infinite, Gated
Start/Stop Phase	0 ° – 360 °
Internal Period	1 μ s – 500 s
Gated Source	External Trigger
Trigger Source	Internal, External, Manual
Phase Offset	
Range	0 ° – 360 °

Resolution	0.1 °
Trigger Characteristics	
Trigger Input	
Input Level	TTL compatible
Slope	Rising or Falling, selectable
Pulse Width	> 100 ns
Input Impedance	> 5 k Ω , DC coupling
Maximum Frequency	1 MHz
Input Latency	< 300 ns
Trigger Output	
Voltage Level	TTL compatible
Pulse Width	> 400 ns
Output Impedance	50 Ω
Maximum Frequency	1 MHz
Modulation Characteristics	
Amplitude Modulation	
Carrier	Sine, Square, Ramp, Arbitrary (except DC)
Source	Internal, External
Modulation Waveform	Sine, Square, Ramp, Noise, Arbitrary (2 mHz – 20 kHz)
Modulation Depth	0 % - 120 %
Frequency Modulation	
Carrier	Sine, Square, Ramp, Arbitrary (except DC)
Source	Internal, External
Modulation Waveform	Sine, Square, Ramp, Noise, Arbitrary (2 mHz – 20 kHz)
Frequency Deviation	0 – 0.5*bandwidth, 10 μ Hz resolution
FSK	
Carrier	Sine, Square, Ramp, Arbitrary (except DC)
Source	Internal, External
Modulation Waveform	50 % duty cycle square waveform (2 mHz – 50 kHz)
ASK	
Carrier	Sine, Square, Ramp, Arbitrary (except DC)
Source	Internal, External
Modulation Waveform	50 % duty cycle square waveform (2 mHz – 50 kHz)
DSB-AM	
Carrier	Sine, Square, Ramp, Arbitrary (except DC)
Source	Internal, External
Modulation Waveform	2 mHz – 1 kHz
Phase Modulation	
Carrier	Sine, Square, Ramp, Arbitrary (except DC)

Source	Internal, External
Modulation Waveform	Sine, Square, Ramp, Noise, Arbitrary (2 mHz – 20 kHz)
Phase Deviation	0 – 360 °, 0.1 ° resolution
PWM Modulation	
Frequency	500 μHz – 20 kHz
Source	Internal, External
Modulation Waveform	Sine, Square, Ramp, Noise, Arbitrary (except DC)
External Modulation	- 6 V to + 6 V (max. width deviation)
Duty Cycle Modulating Frequency	2 mHz – 20 kHz
Sweep Characteristics	
Waveforms	Sine, Square, Ramp, Pulse, Arbitrary (except DC)
Sweep Shape	Linear or Logarithmic, up or down
Sweep Time	1 ms – 500 s
Sweep Trigger	Internal, External, Manual
Inputs and Outputs	
Output Impedance	50 Ω , High impedance
Sync OUT	TTL compatible > 50 ns width, not adjustable 50 Ω (typical) output impedance 2 MHz max. frequency
Modulation In	± 6 Vpp for 100% modulation > 5 kΩ input impedance Max. voltage input: ± 6 V
External Clock	10 MHz ± 100 Hz, TTL compatible for external unit synchronization
Ext Trig/Gate/FSK/Burst	TTL compatible Max. voltage input: ± 6 V
Frequency Counter	
Measurement	Frequency, Period, Positive/Negative pulse width, Duty cycle
Measurement Range (typical)	Single channel: 100 mHz – 200 MHz Pulse width/Duty cycle: 1 Hz – 10 MHz
Frequency Resolution	6 bits
Voltage range (non-modulated signal)	
DC Coupling (typical)	DC Offset Range: ± 1.5 VDC 100 mHz to 10 MHz, 450 mV to ± 2.5 V 10 MHz to 50 MHz, 2.5 V to 5 V 50 MHz to 200 MHz, 4.5 V to 5 V
AC Coupling	1 Hz – 100 MHz, 50 mVrms - 5 Vpp 100 MHz – 200 MHz, 100 mVrms – 5 Vpp
Pulse width/Duty cycle Voltage Range	50 mVrms – 5 Vpp

Input Impedance	1 M Ω
Coupling	AC, DC
Trigger Level Range (typical)	-3 V to +1.8 V
General	
Display Resolution	3.5" TFT-LCD Display, 320 x 240
Remote Control Interface	USBTMC (standard), GPIB (optional)
Storage Memory	10 Instrument settings, 10 Arbitrary waveforms
Dimensions (WxHxD)	213mm x 89 mm x 281 mm (8.4" x 3.5" x 11.1")
Weight	2.6 kg (5.7 lbs)
Power	100 – 240 VAC \pm 10%, 50 / 60 Hz \pm 5% 100 – 120 VAC \pm 10%, 45 – 440 Hz
Power Consumption	50 W max.
Temperature	Operation: 0 $^{\circ}$ C – 40 $^{\circ}$ C Storage: -20 $^{\circ}$ C – 60 $^{\circ}$ C
Humidity	< 35 $^{\circ}$ C, \leq 90 % RH 35 $^{\circ}$ C – 40 $^{\circ}$ C, \leq 60 % RH
Altitude	Operation: Below 3,000 m Storage: Below 15,000 m

SERVICE INFORMATION

Warranty Service: Please go to the support and service section on our website at www.bkprecision.com to obtain a RMA #. Return the product in the original packaging with proof of purchase to the address below. Clearly state on the RMA the performance problem and return any leads, probes, connectors and accessories that you are using with the device.

Non-Warranty Service: Please go to the support and service section on our website at www.bkprecision.com to obtain a RMA #. Return the product in the original packaging to the address below. Clearly state on the RMA the performance problem and return any leads, probes, connectors and accessories that you are using with the device. Customers not on an open account must include payment in the form of a money order or credit card. For the most current repair charges please refer to the service and support section on our website.

Return all merchandise to B&K Precision Corp. with prepaid shipping. The flat-rate repair charge for Non-Warranty Service does not include return shipping. Return shipping to locations in North America is included for Warranty Service. For overnight shipments and non-North American shipping fees please contact B&K Precision Corp.

B&K Precision Corp.
22820 Savi Ranch Parkway
Yorba Linda, CA 92887
www.bkprecision.com
714-921-9095

Include with the returned instrument your complete return shipping address, contact name, phone number and description of problem.

LIMITED ONE-YEAR WARRANTY

B&K Precision Corp. warrants to the original purchaser that its products and the component parts thereof, will be free from defects in workmanship and materials for a period of **one year** from date of purchase.

B&K Precision Corp. will, without charge, repair or replace, at its option, defective product or component parts. Returned product must be accompanied by proof of the purchase date in the form of a sales receipt.

To help us better serve you, please complete the warranty registration for your new instrument via our website www.bkprecision.com

Exclusions: This warranty does not apply in the event of misuse or abuse of the product or as a result of unauthorized alterations or repairs. The warranty is void if the serial number is altered, defaced or removed.

B&K Precision Corp. shall not be liable for any consequential damages, including without limitation damages resulting from loss of use. Some states do not allow limitations of incidental or consequential damages. So the above limitation or exclusion may not apply to you.

This warranty gives you specific rights and you may have other rights, which vary from state-to-state.

B&K Precision Corp.
22820 Savi Ranch Parkway
Yorba Linda, CA 92887
www.bkprecision.com
714-921-9095



22820 Savi Ranch Parkway
Yorba Linda, CA 92887
www.bkprecision.com

© 2013 B&K Precision Corp.

v042018